

C&K D Series Miniature Snap-in Power Rocker Switches



Features/Benefits

- **Low cost**
- **Momentary and maintained models**
- **PC and quick connect terminals**
- **Recessed bracket available—prevents accidental actuation**

Typical Applications

- **Computers**
- **Vacuum cleaners**
- **Coffee makers**

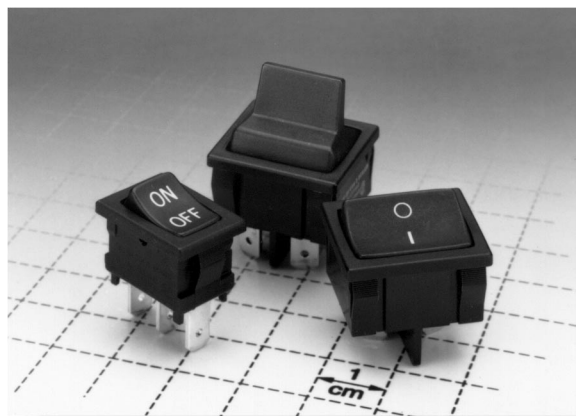

Build-A-Switch

Our easy Build-A-Switch concept allows you to mix and match options to create the switch you need. Below is a complete listing of options shown in catalog. To order, simply select desired option from each category and place in the appropriate box. Switches with standard options are shown on page F-50. Available options are shown and described on pages F-50 thru F-52. For additional options not shown in catalog, consult Customer Service Center.

Typical Example: D 1 0 1 — J 1 — 2 — S 2 — 1 5 — — Q A

Switch Function

- D101** (STD.) SPDT, On-None-On
- D201** (STD.) DPDT, On-None-On
- D501** (STD.) SPDT, On-None-On
- D601** (STD.) DPDT, On-None-On
- D102** SPST, On-None-Off
- D103** SPDT, On-Off-On
- D105** SPDT, Mom.-Off-Mom.
- D108** SPDT, Mom.-None-On
- D202** DPST, On-None-Off
- D203** DPDT, On-Off-On
- D208** DPDT, Mom.-None-On
- D502** SPST, On-None-Off
- D503** SPDT, On-Off-On
- D508** SPDT, Mom.-None-On
- D602** DPST, On-None-Off
- D603** DPDT, On-Off-On
- D608** DPDT, Mom.-None-On

Actuator

- J1** (STD.) Rocker
- J5** Lever

Actuator Color

- 2** (STD.) Black
- 1** White
- 3** Red
- T** Beige

Mounting Style/Color

- S2** (STD.) Snap-in, black
- B2** Recessed snap-in bracket, black
- S1** Snap-in, white
- S3** Snap-in, red
- ST** Snap-in, beige

Terminations

- 15** (STD.) Quick connect
- A** Right angle, PC thru-hole
- 02** PC Thru-hole
- 05** Twisted quick connect
- 06** Extended PC thru-hole
- 17** Wirable quick connect

Actuator Markings

- NONE** (STD.) No marking
- D** ON-OFF
- H** 0 I
- N** Large dot
- P** 0 -
- R** Red rectangle on end
- U** Large dot on end

Contact Material

- QA** (STD.) Silver (UL/CSA)
- QF** (STD.) Silver (UL/CSA/VDE)

Specifications

CONTACT RATING: D10X and D20X Models: 4 AMPS @ 125 V AC; 2 AMPS @ 250 V AC. D50X and D60X Models: 10 AMPS @ 125 V AC; 5 AMPS @ 250 V AC.

ELECTRICAL LIFE: 10,000 make-and-break cycles at full load.

INSULATION RESISTANCE: 10⁹ ohms min.

DIELECTRIC STRENGTH: 1,000 V RMS min. @ sea level.

NOTE: Specifications and materials listed above are for standard switches. For information on specific and custom switches, consult Customer Service Center.

Materials

ACTUATOR & HOUSING: 6/6 nylon (UL 94V-2), color black, standard; finish: matte.

MOVABLE CONTACTS: D10X and D20X Models: Copper, silver plated. D50X and D60X Models: Coin silver, silver plated.

STATIONARY CONTACTS AND TERMINALS: Copper or brass, silver plated.

CONTACT SPRING: Music wire or stainless steel.



F

Rocker

C&K D Series Miniature Snap-in Power Rocker Switches

SWITCHES WITH STANDARD OPTIONS



D102J12S215QA
SPDT

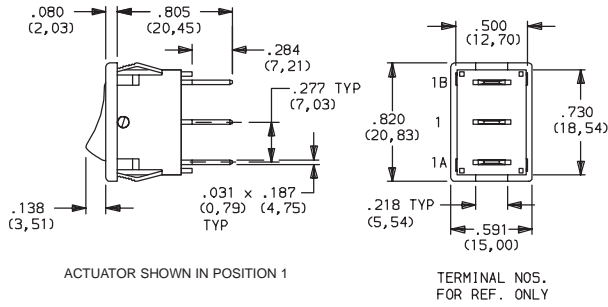

PART NUMBER	FUNCTION	POS. 1	POS. 2	POS. 3
D102J12S215QA	SPDT	ON	NONE	OFF
D501J12S215QA	SPDT	ON	NONE	ON
D502J12S215QA	SPST	ON	NONE	OFF

NOTE: For panel mounting information, see page F-51.

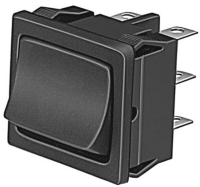

D201J12S215QA
DPDT

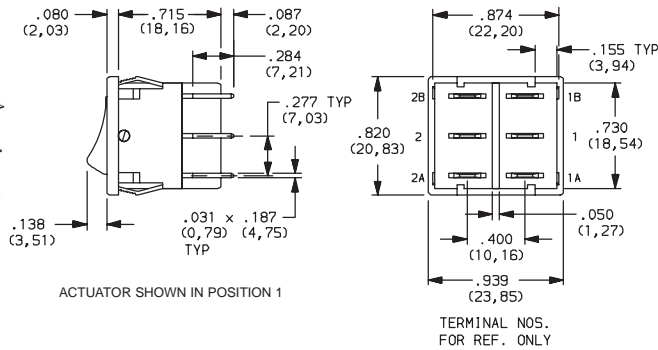

PART NUMBER	FUNCTION	POS. 1	POS. 2	POS. 3
D201J12S215QA	DPDT	ON	NONE	ON
D602J12S215QA	DPST	ON	NONE	OFF

NOTE: For panel mounting information, see page F-51.

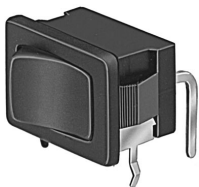

D501J12S2AQA
Horizontal Actuation
SPDT

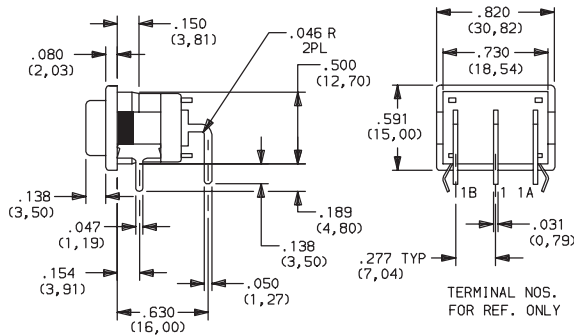

PART NUMBER	FUNCTION	POS. 1	POS. 2	POS. 3
D501J12S2AQA	SPDT	ON	NONE	ON

NOTE: For PC mounting information, see page F-52.

SWITCH FUNCTION

NO. POLES	MODEL NO.	AMP RATING*	SWITCH FUNCTION			CONNECTED TERMINALS			SCHEMATIC
			POS. 1	POS. 2	POS. 3	POS. 1	POS. 2	POS. 3	
SP	D102	4	ON	NONE	OFF	1-1A	OPEN	OPEN	
	D502	10							
	D101 (STD.)	4	ON	OFF	ON	1-1A	OPEN	1-1B	
	D501 (STD.)	10							
	D103	4	MOM.	OFF	MOM.				
	D503	10							
D105	4	MOM.	OFF	MOM.					
D108	4	MOM.	NONE	ON					
D508	10								

MOM. = MOMENTARY

*AMP RATING: D10X and D20X models: 4 AMPS @ 125 V AC; 2 AMPS @ 250 V AC. D50X and D60X models: 10 AMPS @ 125 V AC; 5 AMPS @ 250 V AC.

All models . DX01, DX02 models also available with . See CONTACT MATERIALS, page F-52.

C&K D Series Miniature Snap-in Power Rocker Switches

SWITCH FUNCTION

NO. POLES	MODEL NO.	AMP RATING*	SWITCH FUNCTION			CONNECTED TERMINALS			SCHEMATIC
			POS. 1	POS. 2	POS. 3	POS. 1	POS. 2	POS. 3	
DP	D202 D602	4 10	ON	NONE	OFF	1-1A, 2-2A	OPEN	OPEN	
	D201 (STD.) D601 (STD.)	4 10	ON	NONE	ON	1-1A, 2-2A	OPEN	1-1B, 2-2B	
	D203 D603	4 10		OFF					
	D208 D608	4 10	MOM.	NONE					

MOM. = MOMENTARY

*AMP RATING: D10X and D20X models: 4 AMPS @ 125 V AC; 2 AMPS @ 250 V AC. D50X and D60X models: 10 AMPS @ 125 V AC; 5 AMPS @ 250 V AC.

All models . DX01, DX02 models also available with . See CONTACT MATERIALS, page F-52.

ACTUATOR

J1 (STD.) ROCKER

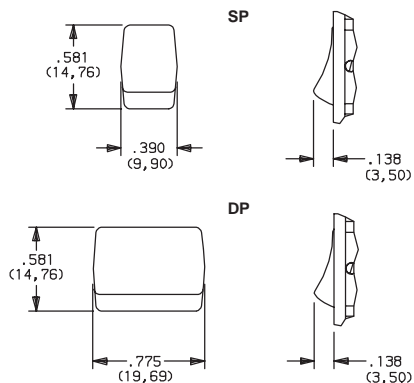

J5 LEVER

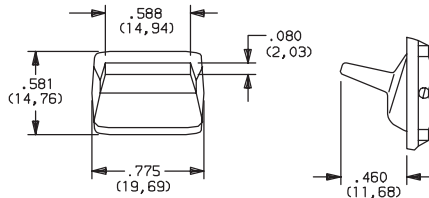

'J5' actuator available only with DP models D201, D202, D601 and D602.

OPTION CODE	ACTUATOR COLOR
2	(STD.) BLACK
1	WHITE
3	RED
T	BEIGE

NOTE: Actuator finish: matte. Other colors available, consult Customer Service Center.

MOUNTING STYLE/COLOR

S (STD.) SNAP-IN

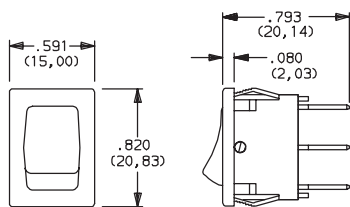

OPTION CODE	HOUSING COLOR
2	(STD.) BLACK
1	WHITE
3	RED
T	BEIGE

NOTE: Frame finish on housing: matte. Other colors available, consult Customer Service Center.

B RECESSED SNAP-IN BRACKET

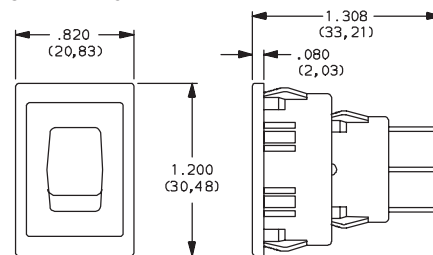

NOTE: Available in black, vertical mount, SP models only.

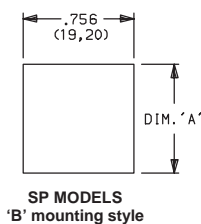
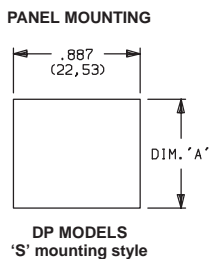
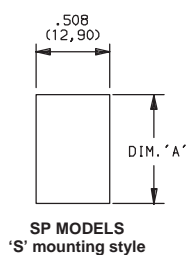

PANEL THK.	DIM. 'A' SP & DP MODELS 'S' MOUNTING STYLE	DIM. 'A' SP MODELS 'B' MOUNTING STYLE
.030-.049 (0,75) (1,25)	.756 (19,20)	1.068 (27,13)
.049-.079 (1,25) (2,00)	.764 (19,40)	1.076 (27,33)
.079-.118 (2,00) (3,00)	.780 (19,80)	1.092 (27,74)



F

Rocker

C&K D Series Miniature Snap-in Power Rocker Switches

TERMINATIONS

A RIGHT ANGLE, PC THRU-HOLE

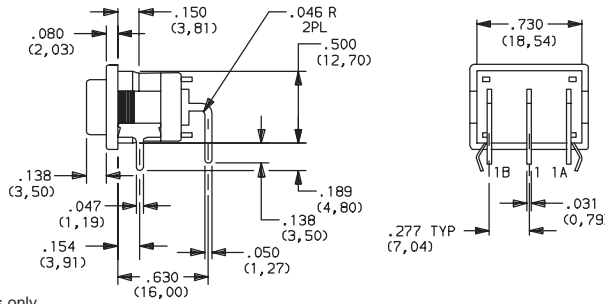
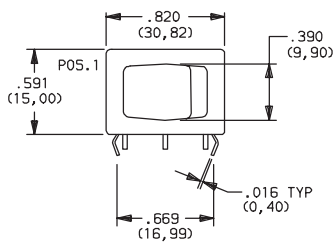

PC MOUNTING

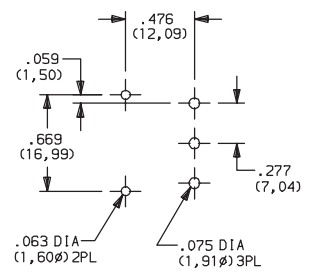

Available with D101, D102, D501, D502 SP models only.

02 PC THRU-HOLE

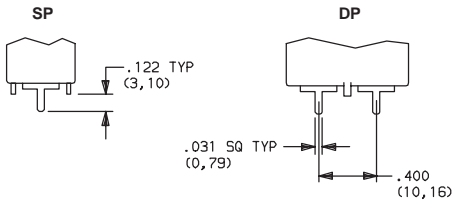

06 EXTENDED PC THRU-HOLE

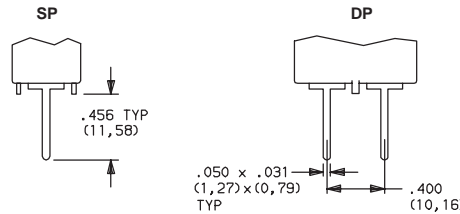

PC MOUNTING (02 and 06)

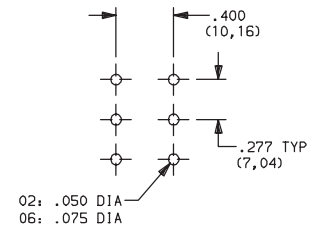

Available with DX01 and DX02 models only.

Available with DX01 and DX02 models only.

15 (STD.) QUICK CONNECT

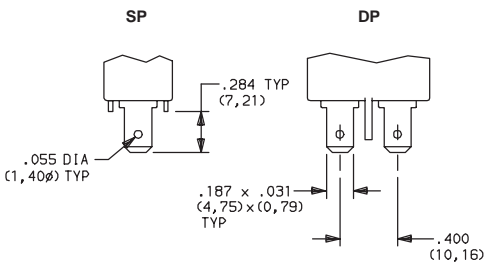

05 TWISTED QUICK CONNECT

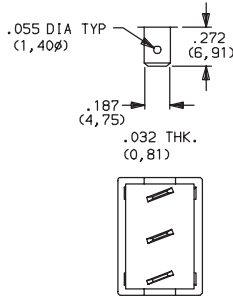

Available with DX01 and DX02 models only.

NOTE: Terminals are twisted. Available with DX03, DX05 and DX08 models only.

17 WIRABLE QUICK CONNECT

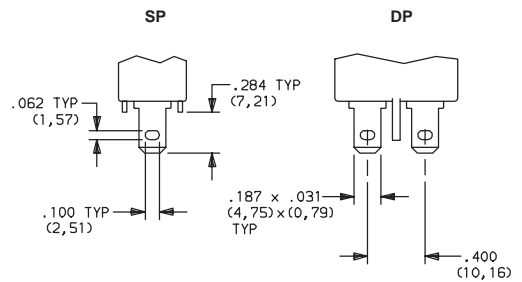

Available with DX01 and DX02 models only.

ACTUATOR MARKINGS

NONE (STD.) NO MARKING **D** ON-OFF **H** O I **N** LARGE DOT **P** O- **R** RED RECTANGLE ON END **U** LARGE DOT ON END

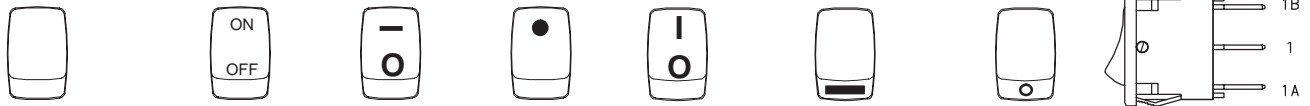

'D, H, P & U' marking options: marking color white, standard for all actuator colors except white. Black marking color, standard for white actuators. 'R' & 'N' marking option: red marking color, standard. consult Customer Service Center for other available marking colors.

NOTE: Orientation of actuator markings and terminals.

CONTACT MATERIAL

OPTION CODE	CONTACT AND TERMINAL MATERIAL	RATINGS
QA (STD.)	SILVER ¹	D10X and D20X MODELS: 4 AMPS @ 125 V AC; 2 AMPS @ 250 V AC (UL/CSA). D50X and D60X MODELS: 10 AMPS @ 125 V AC; 5 AMPS @ 250 V AC (UL/CSA).
QF (STD.)		D10X and D20X MODELS: 4 AMPS @ 125 V AC; 2 AMPS @ 250 V AC (UL/CSA). 4(2) AMPS @ 125 V AC; 2(1) AMPS @ 250 V AC, T85 (VDE). 2(1) AMPS @ 250 V AC. D50X and D60X MODELS: 10 AMPS @ 125 V AC; 5 AMPS @ 250 V AC (UL/CSA). 10(6) AMPS @ 125 V AC; 5(3) AMPS @ 250 V AC, T85 (VDE). 5(3) AMPS @ 250 V AC.

¹MOVABLE CONTACT: D10X and D20X MODELS: Copper, silver plated.
D50X and D60X MODELS: Coin silver, silver plated.
STATIONARY CONTACTS & TERMINALS: Copper or brass, silver plated.

All models with all options. DX01, DX02 models when ordered with 'QF' contact material.