



# SERIES 500 SWITCHES

## SLIDE SWITCHES

TACT SWITCHES

NAVIGATION SWITCHES

PUSHBUTTON SWITCHES

TOGGLE SWITCHES

ROCKER SWITCHES

SLIDE SWITCHES

SNAP-ACTION SWITCHES

DIP SWITCHES

KEYLOCK SWITCHES

ROTARY SWITCHES

DETECTOR SWITCHES

CAP. OPTIONS



### SPECIFICATIONS

Contact Rating:	Gold, 0.4 VA @ 20 VAC or DC Silver, 5A @ 120 VAC, 2A @ 250 VAC cURus
Life Expectancy:	30,000 make-and-break cycles at full load
Contact Resistance:	10 mΩ max. typical @ 2-4 VDC 100mA for both silver and gold plated contacts
Insulation Resistance:	1,000 MΩ min.
Dielectric Strength:	1,000 V rms at sea level
Operating Temperature:	-30°C to 85°C

### FEATURES & BENEFITS

- ▶ Single & double pole options
- ▶ Multiple actuator height options
- ▶ Panel & PC board mountable

### APPLICATIONS/MARKETS

- ▶ Computer servers/peripherals
- ▶ Consumer electronics
- ▶ Instrumentation
- ▶ Test & measurement

### MATERIALS

Case:	Diallyl phthalate (DAP), UL 94V0
Housing:	Stainless steel
Slide Handle:	Nylon UL 94HB
Contacts:	Silver or gold plated copper alloy

### HOW TO ORDER

SERIES	MODEL NO.	ACTUATOR	TERMINATION	CONTACT MATERIAL	SEAL	MOUNTING TAB
500	SSP1 SSP2 SSP3	S1 S2 S3 S4	M1 M2 M3 M5-1 M5-2 M5-3 M5-4 M6 M7 VS2	Q = Silver R = Gold	E = Epoxy Sealed	A = Without Tabs B = With Tabs

▶ ▶ ▶ Example Ordering Number  
500-SSP2-S4-M1-Q-E-B

SDP1 SDP3	S1 S2 S3 S4 S5	M1 M2 M3 M5-1 M5-2 M5-3 M5-4 M6 M7 VS2	Q = Silver R = Gold	E = Epoxy Sealed	A = Without Tabs B = With Tabs
--------------	----------------------------	---	------------------------	------------------	-----------------------------------

▶ ▶ ▶ Example Ordering Number  
500-SDP1-S1-M6-R-E-A

Specifications subject to change without notice.



## SPDT



2 Comm.  
1 3

SCHEMATIC

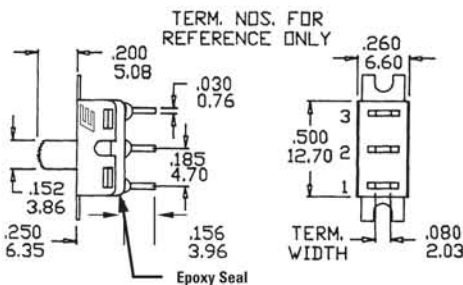
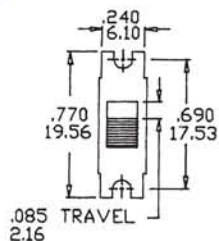

Model No.	POS 1	POS 2	POS 3
SSP-1	ON	NONE	ON
SSP-2	ON	NONE	(ON)
SSP-3	ON	OFF	ON
Term. Comm.	2-1	OPEN	2-3

( ) = Momentary

## DPDT



2 Comm. 5 Comm.  
1 3 4 6

SCHEMATIC

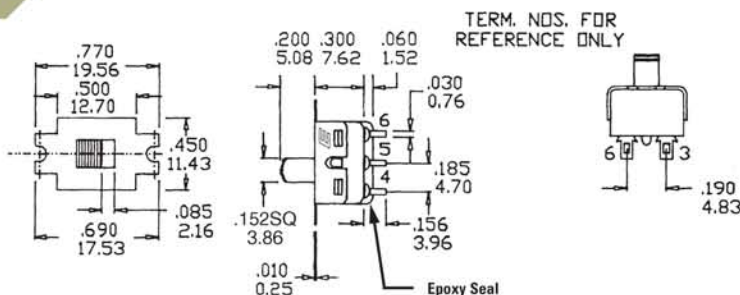

Model No.	POS 1	POS 2	POS 3
SDP-1	ON	NONE	ON
SDP-3	ON	OFF	ON
Term. Comm.	2-1, 5-4	OPEN	2-3, 5-6

## ACTUATOR OPTIONS

**S1 STD†**

† Standard for all DPDT versions.

**S2**

**S3**

**S4**

**S5**

\* Subtract 0.012 (0.301) from actuator height for M6, M7 PC mounting options.

## TERMINATION OPTIONS

**M1 SOLDER LUG**

0.030 (0.76) THK

**M2 P.C. MOUNT**

0.030 (0.76) THK

**M3 QUICK CONNECT**

0.030 (0.76) THK  
MATING QUICK CONNECTOR  
AMP P/N 60900-1

**M5 WIRE WRAP**

Option Code	Dim. 'A'
M51	.736 (18.70)
M52	.953 (24.20)
M53	.415 (10.55)
M54	1.062 (26.97)



# SERIES 500 SWITCHES

## SLIDE SWITCHES

TACT SWITCHES

NAVIGATION SWITCHES

PUSHBUTTON SWITCHES

TOGGLE SWITCHES

ROCKER SWITCHES

SLIDE SWITCHES

SNAP-ACTION SWITCHES

DIP SWITCHES

KEYLOCK SWITCHES

ROTARY SWITCHES

DETECTOR SWITCHES

CAP OPTIONS

### M6

SPDT

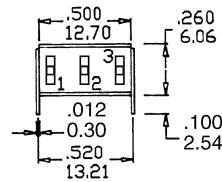
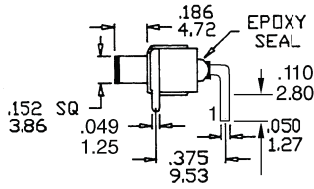
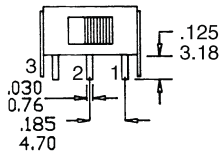

TERM. NOS. FOR REFERENCE ONLY

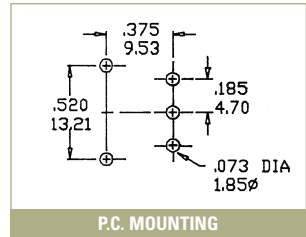

P.C. MOUNTING

### M6

DPDT

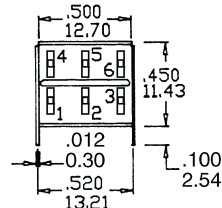
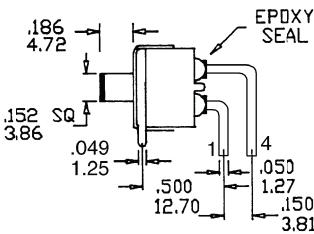
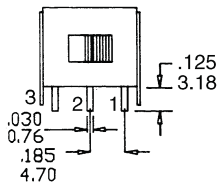

TERM. NOS. FOR REFERENCE ONLY

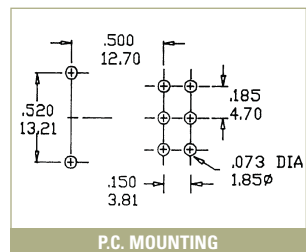

P.C. MOUNTING

### M7

SPDT

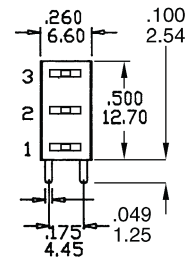
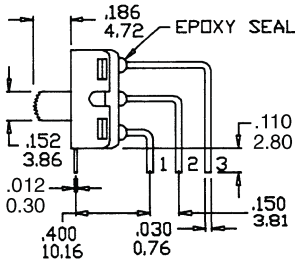
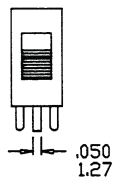

TERM. NOS. FOR REFERENCE ONLY

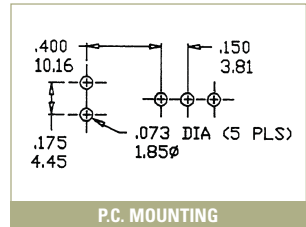

P.C. MOUNTING

### M7

DPDT

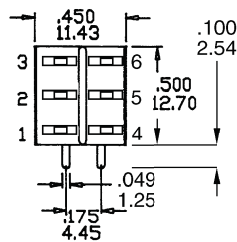
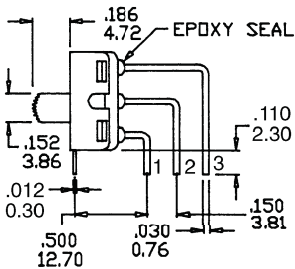
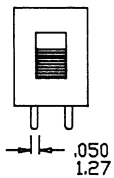

TERM. NOS. FOR REFERENCE ONLY

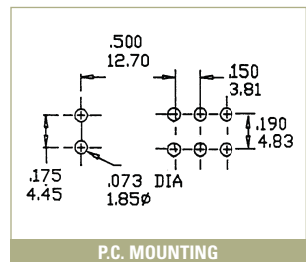

P.C. MOUNTING

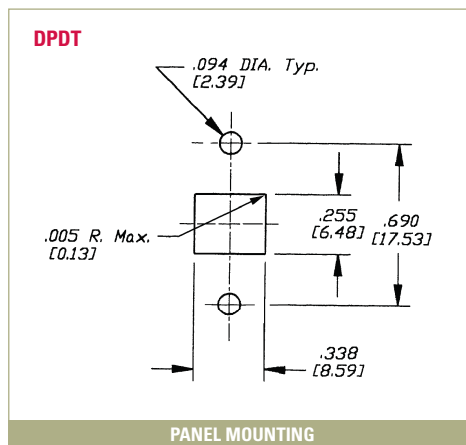
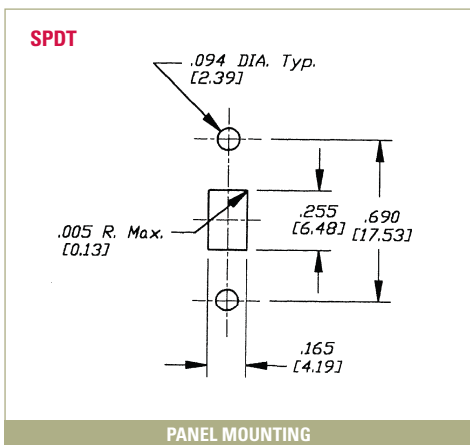

**MOUNTING TABS**

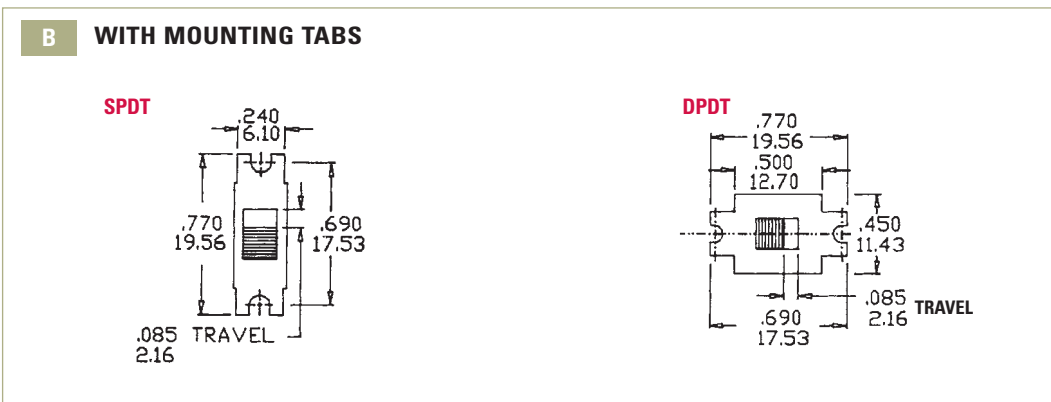
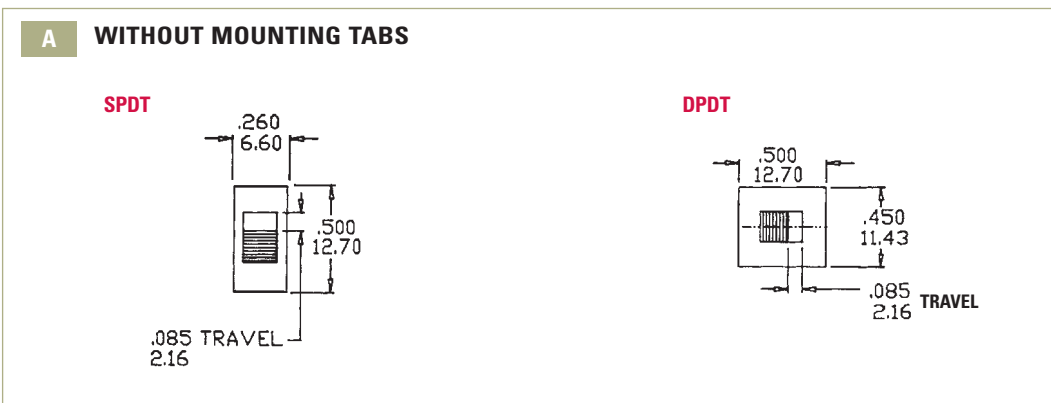

**CONTACT MATERIAL OPTIONS**

<b>Q</b>	Fixed Terminal: Silver plated copper alloy
	Moving Contact: Silver plated copper alloy
	Rating: 5 Amps with resistive load @ 120VAC or 28VDC 2 Amps with resistive load @ 250VAC

<b>R</b>	Fixed Terminal: Copper alloy with gold plate over nickel plate
	Moving Contact: Copper alloy with gold plate over nickel plate
	Rating: 0.4 Volt-Amps (VA) max. @ 20V max. (AC or DC)