



**SURFACE MOUNT RESISTORS  
TECHNICAL GUIDE**

**Ver. 3**

**Device Solutions Business Division  
Automotive & Industrial Systems Company  
Panasonic Corporation**

## Contents

1. First:	.....2 page
2. Construction of Surface Mount Resistors:	.....3 page
3. Manufacturing Method of Thick-film Chip Resistors:	.....4 page
4. System of Surface Mount Resistors:	.....5 page
5. Kinds of Surface Mount Resistors:	.....6 page
6. Reliability:	.....7 page
7. Failure Mechanism:	.....8 page
8. Application Notes:	.....9 to 10 page
9. Technique	
9.1. Circuit Design:	.....11 to 17 page
9.2. Design of Printed Substrate:	.....18 to 19 page
9.3. Used Environment:	.....20 to 22 page
9.4. Mounted Method:	.....22 to 25page
10. Technical Trend in the Future:	.....26 to 27 page

## 1. First

Fixed resistors are principal electronic components composed electronic circuit. They are developed with demands of various electronic circuits and used. This technical guide is summarized the application technique about surface mount resistors used for electric machine and tools, especially, which need high density mount in these fixed resistors,

For selection of various surface mount resistors, confirm with the characteristic of that circuit, in general, following step is proper.

- (1) Single chip resistor or Composite chip resistor
- (2) Single chip resistor: Thick-film chip resistor or Thin-film chip resistor
- (3) Composite chip resistor: Chip resistor array (common terminal circuit) or  
Chip resistor network (isolated circuit)
- (4) Select the shape of surface mount resistors in accordance with using voltage (power).

In our company, there are numerous kinds of surface mount resistors in order to respond customer's various needs. However, we are happy if you could understand the contents of this technical guide, and talk over technical contents with us before use, so that you can use it more stability.

Moreover, it is separately introduced as for other fixed resistors, components of noise countermeasure and so on.

**This technical guide might change.**

## 2. Construction of Surface Mount Resistors

The construction figures of representative surface mount resistors are shown below (Fig 1 to Fig 6). It is different a little by the application of surface mount resistors. Foundation substrate: alumina substrate, Termination: thick-film conductive element, Resistance: thick-film resistor or thin-film resistor.

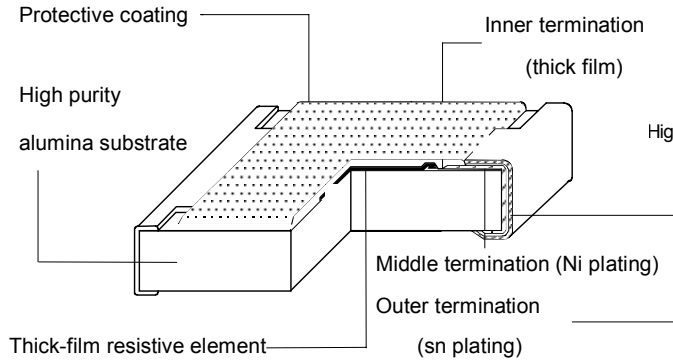

Fig.1. Thick-film chip resistor

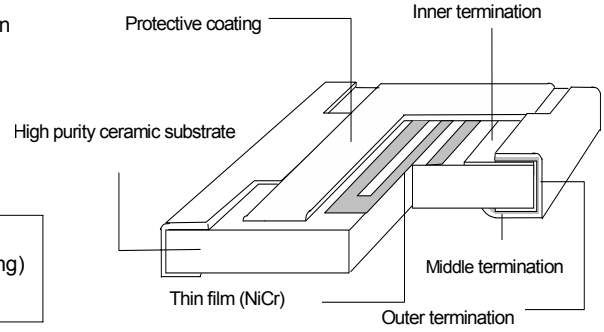

Fig.2. Thin-film chip resistor

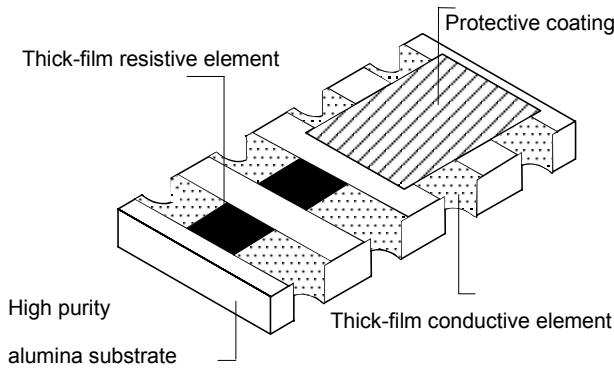

Fig.3. Chip resistor array (concave-type)

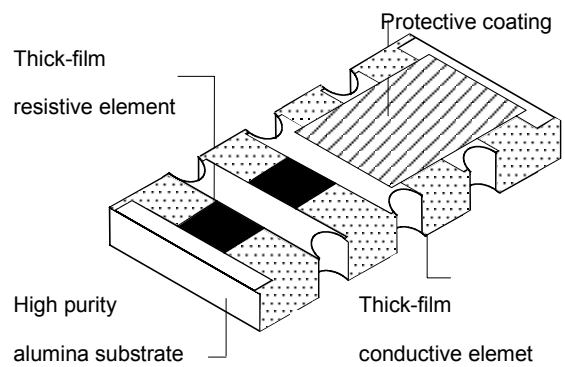

Fig.4. Chip resistor array (convex-type)

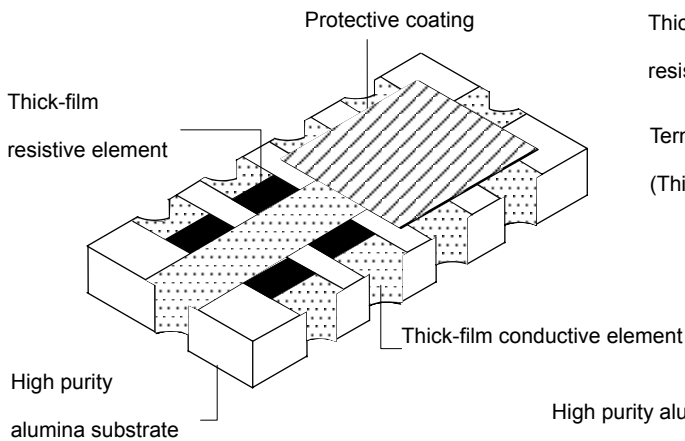

Fig.5. Chip resistor network (concave-type)

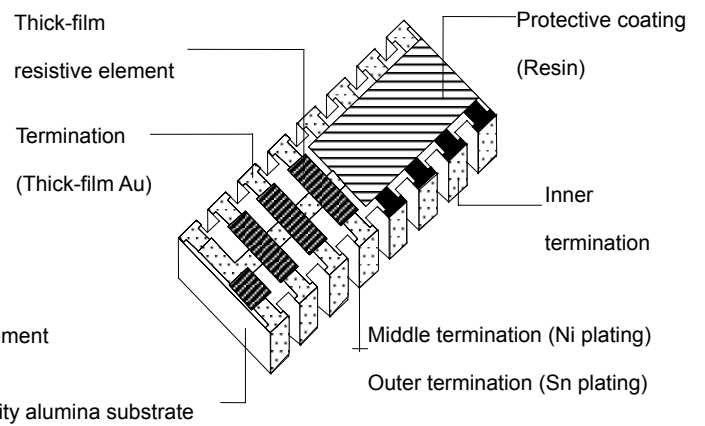

Fig.6. Chip resistor network (convex-type)

### 3. Manufacturing Method of Thick-film Chip Resistors

Manufacturing method of thick film chip resistors of surface mount resistors (the most representative) is shown Fig.7.

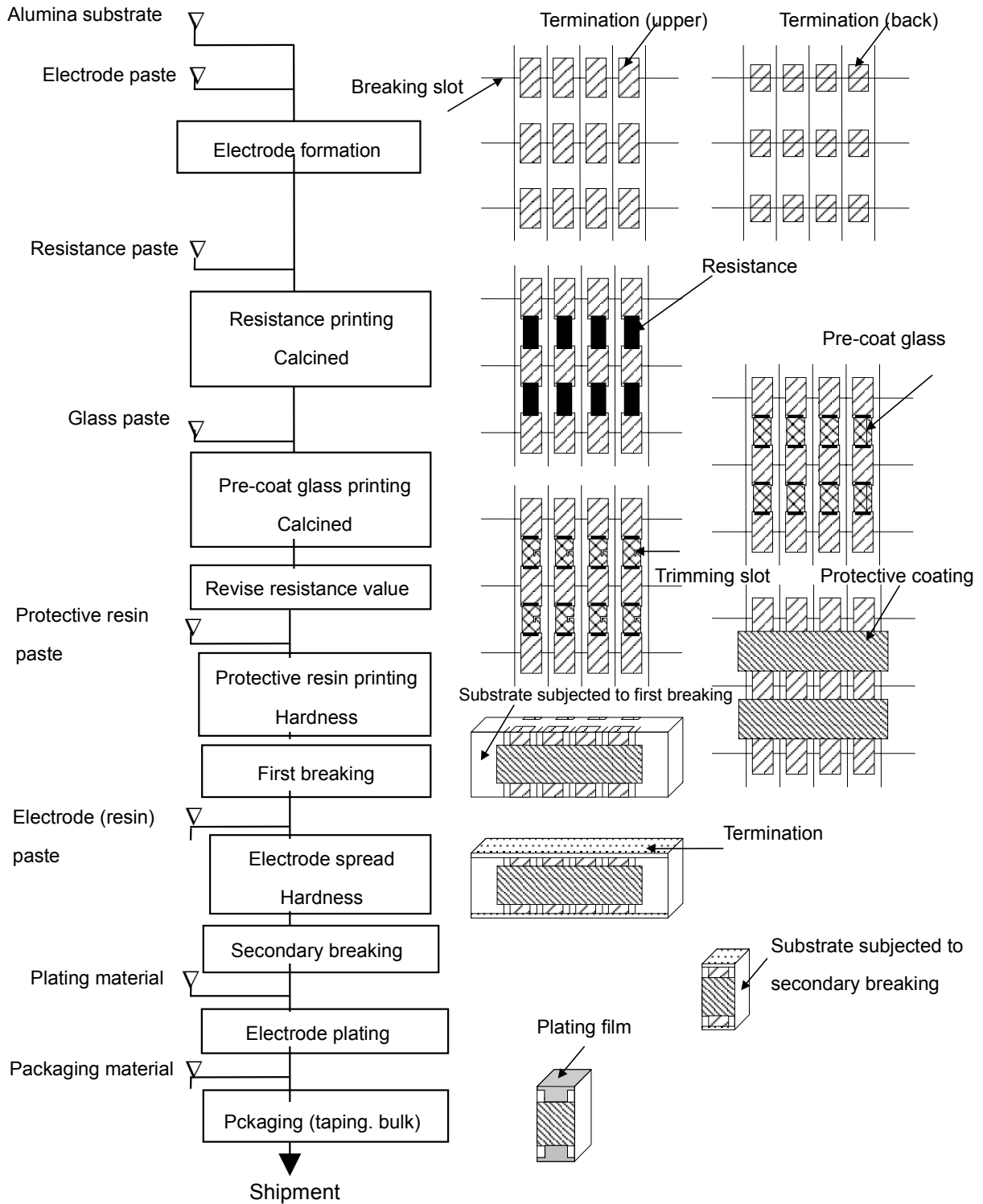

Fig.7. Manufacturing process chart of thick-film chip resistor

## 4. System of Surface Mount Resistors

The range of resistance value and resistance temperature characteristic (TCR) of thick-film chip resistor

resistor (by kind) are shown in Fig.8.

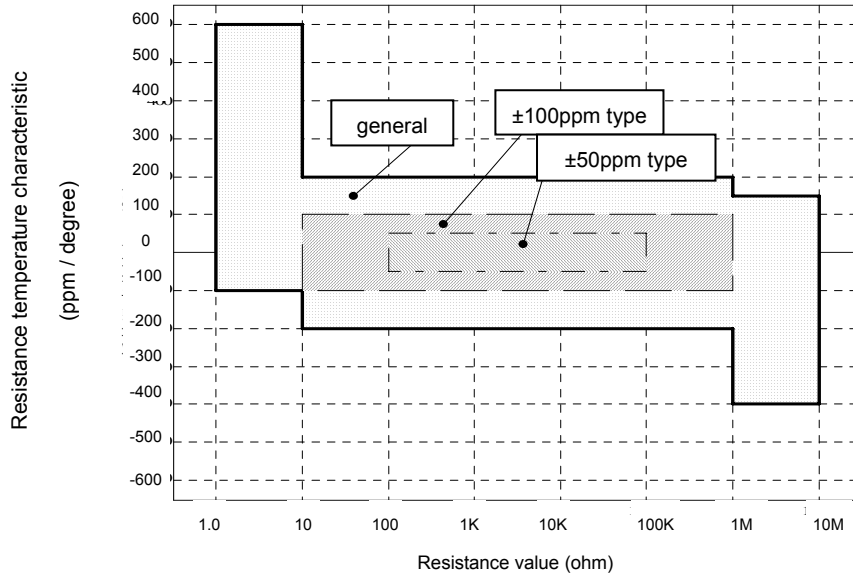

Fig.8. System figure of thick-film chip resistor

The range of resistance value and TCR of thin-film chip resistor (by kind) are shown in Fig.9.

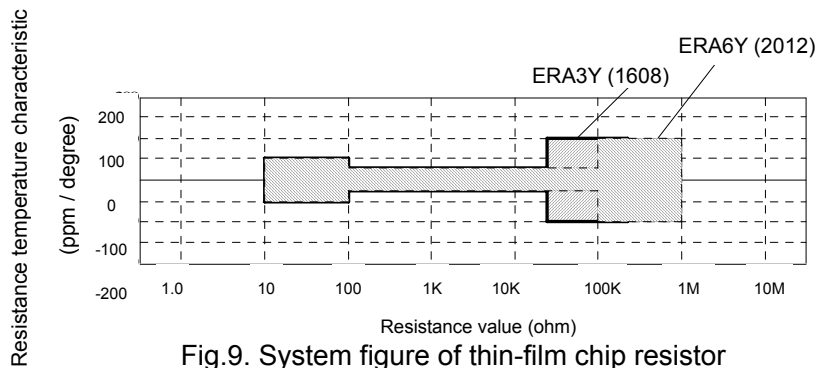
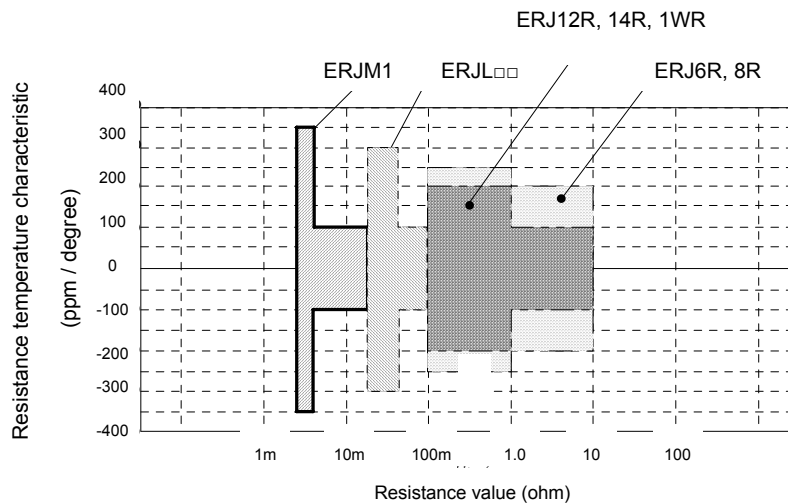

Fig.9. System figure of thin-film chip resistor

The range of resistance value and TCR of thin-film chip resistor (by kind) are shown in Fig.10.

Fig.10. System figure of thin-film chip resistor (low resistance value)



## 5. Kinds of Surface Mount Resistors

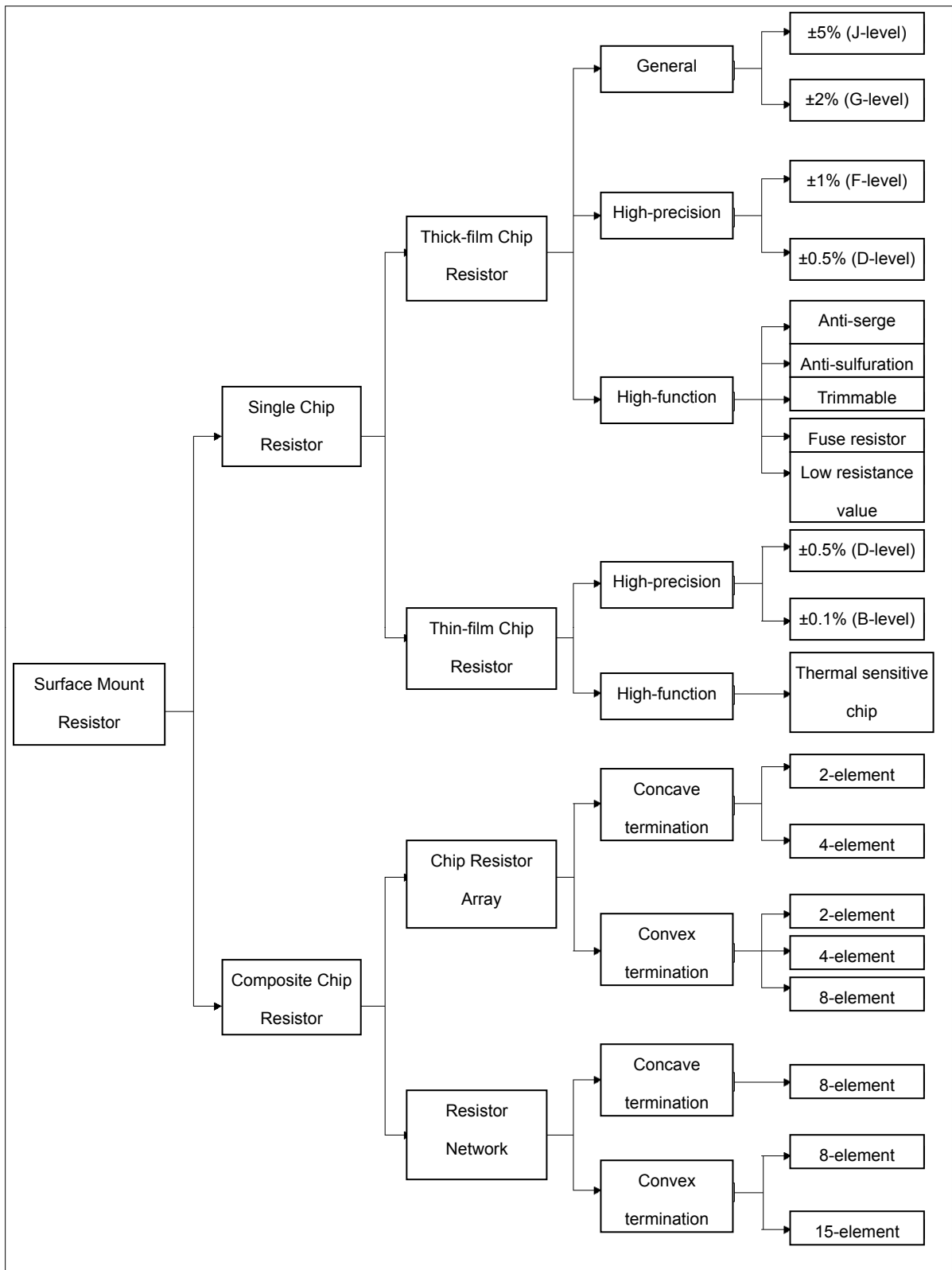

Fig.11. Kinds of surface mount resistors

## 6. Reliability

Field failure rate of surface mount resistors (thick-film chip resistors) is shown in the table-1.

(Set : television)

Table-1: Field failure rate

Products (Shape)	Quantity of used parts (n)	Used time (n x T)	Failure (r)	Failure rate (fit)	
				Point estimation (λ 0)	Reliability level 60% (λ 60)
ERJ2G (1005)	1.21x10 <sup>10</sup> (From 1990)	5.86x10 <sup>13</sup> (From 1990)	0	0.0	0.0000156
ERJ3G (1608)	5.64x10 <sup>10</sup> (From 1986)	4.41x10 <sup>14</sup> (From 1986)	0	0.0	0.0000020
ERJ6G (2012)	1.20x10 <sup>11</sup> (From 1986)	1.38x10 <sup>15</sup> (From 1986)	0	0.0	0.0000006
ERJ8G (3216)	5.06x10 <sup>10</sup> (From 1986)	8.38x10 <sup>14</sup> (From 1986)	0	0.0	0.0000011
ERJ14 (3225)	1.11x10 <sup>9</sup> (From 1987)	7.66x10 <sup>12</sup> ( From 1987)	0	0.0	0.0001200
ERJ12 (4532)	1.01x10 <sup>9</sup> (From 1987)	7.25x10 <sup>12</sup> (From 1987)	0	0.0	0.0001268
ERJ1W (6432)	1.53x10 <sup>8</sup> (From 1990)	8.87x10 <sup>11</sup> (From 1990)	0	0.0	0.0010360

\* Used time (T) = Use 6 hours / a day × 365 days

<Calculating method of failure rate>

Reliability level = 60%

$$\text{Reliability guaranteed coefficient of market fraction defective} = \frac{\chi^2 \{2 (r + 1), \alpha\}}{2}$$

(When it is "0")

$$= 0.92$$

$$\text{Market fraction defective } \lambda_{60} = \frac{\chi^2 \{2 (r + 1), \alpha\}}{2 (n \times T)} \times 10^9$$

$$= \frac{0.92}{n \times T} \times 10^9 \text{ (fit)}$$



## 7. Failure Mechanism

Failure mechanism of thick-film chip resistor and chip resistor array is shown in Fig.12, Failure mechanism of thin-film chip resistor is shown in Fig.13. As destruction mode, it could be resistance value open or large changing of resistance value, it could not be short circuit mode of resistors,

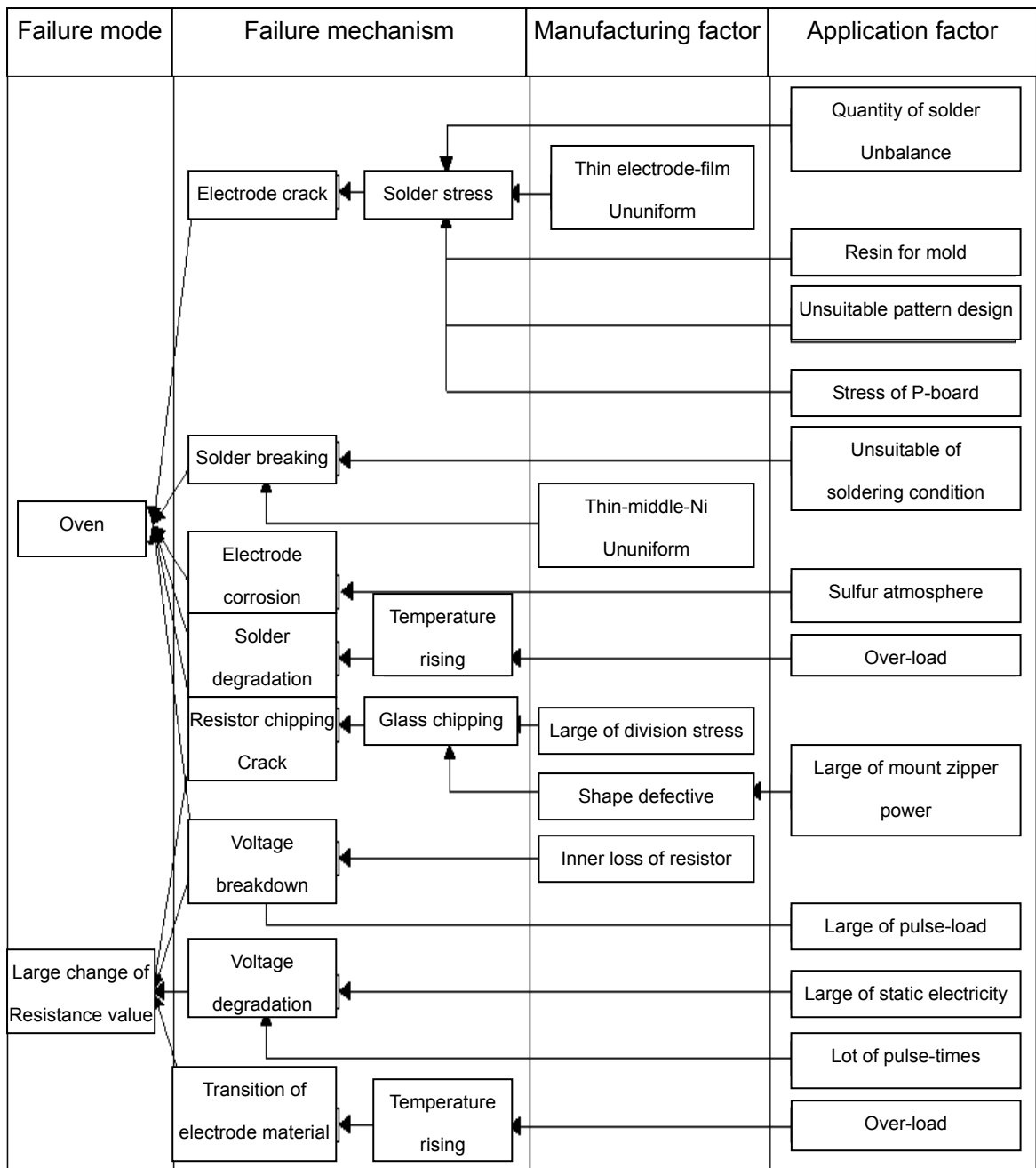

Fig.12. Failure mechanism

(Chip fixed resistors, Chip resistor array, Chip resistor network)

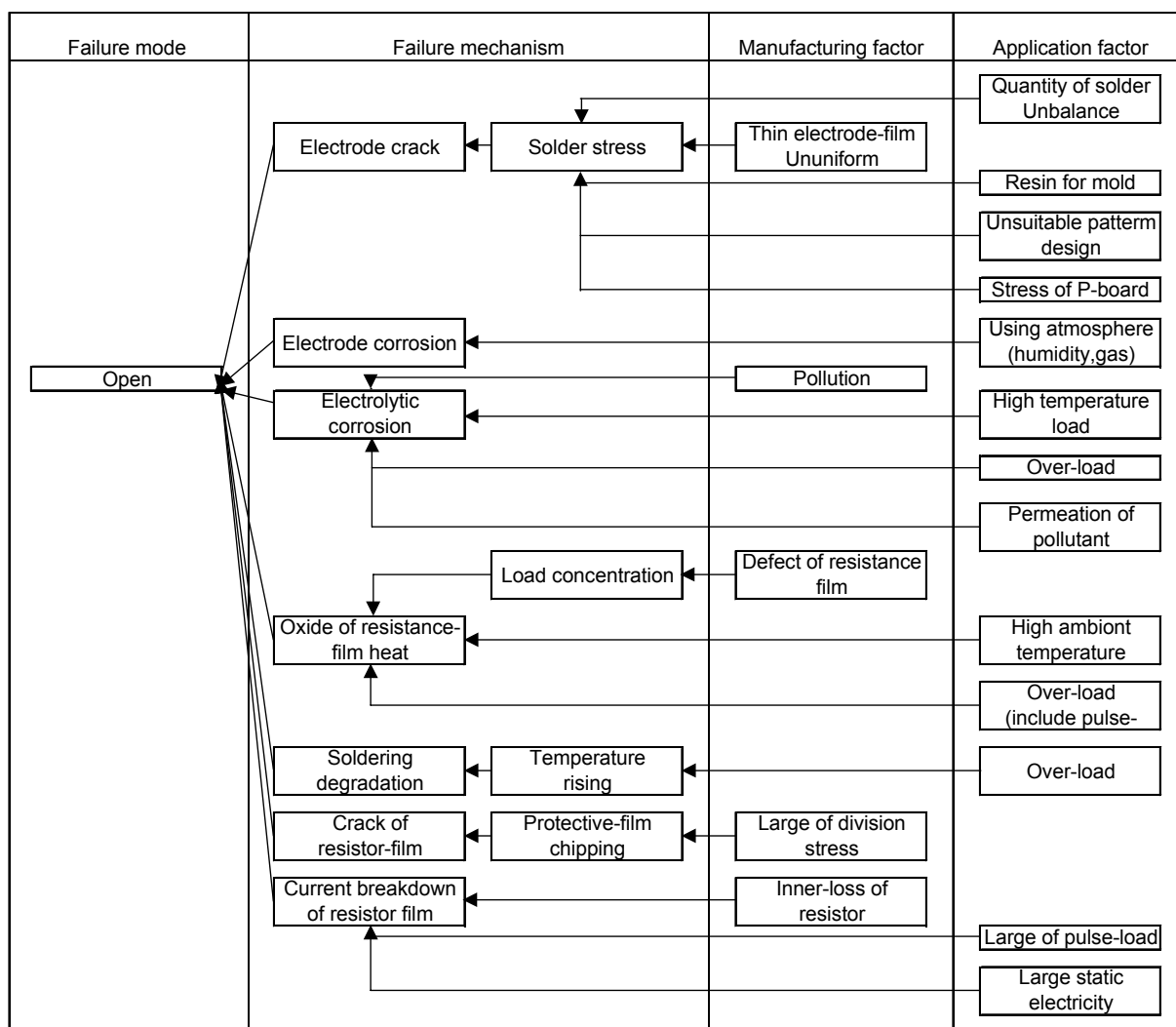

Fig.13. Failure mechanism of thin-film chip resistors

## 8. Application Note

### 8.1. Precautions in handling resistors

Our products are intended for use in general standard applications for general electronic equipment (AV products, household electric appliances, office equipment, information and communication equipment, etc.); hence, they do not take the use under the following special environments into consideration. Accordingly, the use in the following special environments, and such environments, and such environmental conditions may affect the performance of the products; prior to use, verify the performance, reliability, etc.

- (1). Use in liquids such as water, oil, chemical, and organic solvent.
- (2). Use under direct sunlight and in outdoor and dusty atmospheres.
- (3). Use in places full of corrosive gasses such as sea breeze, Cl<sub>2</sub>, H<sub>2</sub>O, NH<sub>3</sub>, SO<sub>2</sub>, and NO<sub>x</sub>.
- (4). Use in environment with large static electricity and strong electromagnetic waves.

- (5). Where the product is close to a heating component, and where an inflammable such as a polyvinyl chloride wire is arranged close to the product.
- (6). Where the resistor is sealed and coated with resin, etc.
- (7). Where water or a water-soluble detergent is used in cleaning free soldering and in flux cleaning after soldering (Pay particular attention to water-soluble flux.)

## 8.2. Requests

- (1). This technical guide is summarized technical contents of surface mount resistors (produced and sold by our company) so that customer can use it properly.
- (2). In traffic transportation equipment (trains, cars, traffic signal equipment, etc.), medical equipment, aerospace equipment, electric heating appliances, combustion and gas equipment, rotating equipment, disaster and crime preventive equipment, etc. in cases where it is forecast that the failure of this product gives serious damage to the human life and others, use fail-safe design and ensure safety by studying the following items to.
  - \* Ensure safety as the system by setting protective circuits and protective equipment.
  - \* Ensure safety as the system by setting such redundant circuits as do not cause danger by a single failure.
- (3). When it is happened that a doubt about safety of this product, let us know quickly and you must examine technically.
- (4). If transient load (heavy load in a short time) like pulse is expected to be applied, carry out evaluation and confirmation test with the resistors actually mounted on your own board. Moreover, if it is used under the specific condition, talk over it beforehand.
- (5). High-active flux as halogen-type (chlorine, bromine, etc) is not recommended as the residue may affect performance or reliability of resistors. Confirm it before use.
- (6). When soldering with soldering iron, never touch the body of the chip resistor with a tip of the soldering iron. When using a soldering iron with a tip at high temperature, solder for a time as short as possible.(up to 350 degree, less than 3 seconds)
- (7). Avoid physical shock to the resistor and nipping of the resistor with hard tool (pliers or tweezers) as it may damage protective coating or body of resistor and may affect resistor's performance.
- (8). Avoid immersion of chip resistor in solvent for a long time. Use solvent after the effect of immersion is confirmed.

## 8.3. Storage method

If the product is stored in the following environments and conditions, the performance and solderability maybe badly affected. Avoid the storage in the following environment.

- (1). Storage in places full of corrosive gasses such as sea breeze, Cl<sub>2</sub>, H<sub>2</sub>S, NH<sub>3</sub>, SO<sub>2</sub>, and NO<sub>2</sub>.
- (2). Storage in places exposed to direct sunlight.

- (3). Storage in places outside the temperature range of 5deg to 35deg and humidity range of 45% to 85%RH.
- (4). Storage over a year after our delivery (This item also applies to the case where the storage method specified in item (1) to (3) has been followed.

## 9. Technique

### 9.1. Circuit design

If using surface mount resistors, pay attention the following performance. (Primarily for film-chip resistors.)

#### 9.1.1. Resistor noise

In general, resistor noise is calculated from the following formula.

Resistor noise = thermal fuse + 1 / f noise

It is thermal noise that depends on shake of speed distribution by clash of carrier and grid. It is 1 / f-noise that factor, which controlled electric current, shakes in some cause and, as the result, it arises from density of carrier and modulation of electric current. It is thought to be in proportion to a reciprocal of frequency.

Regarding thick-film chip resistor, it is formed resistance value by connect resistance. Therefore, 1 / f-noise shall be primarily noise, and it is calculated from the following formula.

$$\text{Noise Index (dB)} = A - 10 \text{ Log } (w \cdot l \cdot t)$$

A: Resistive material, value by manufacturing condition

w · l · t: W-dimensions, L-dimensions, t-dimensions

Noise level average of chip resistor by shape is shown in Fig.14.

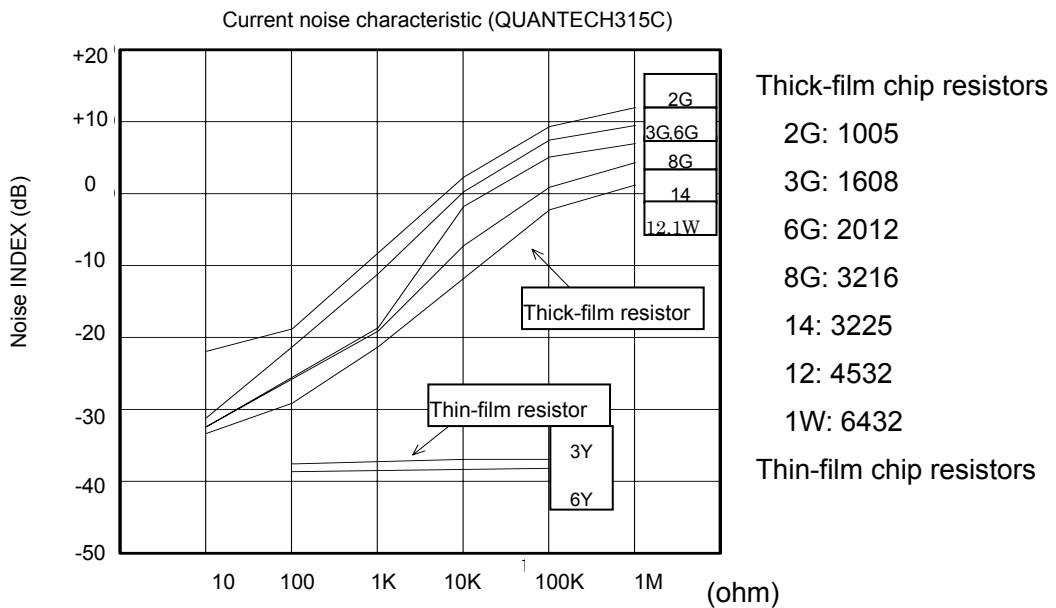

Fig.14. Noise level average of chip resistor

From Fig.14, a noise level tends to become large, so that form becomes small. Therefore, in the circuit that attaches importance to the noise-characteristic, chip resistor of large shape or thin-film chip resistor is recommended.

9.1.1. Over-load characteristic of chip resistor

There are the following 3 cases in the over-load phenomenon of chip resistors.

- \* Over-load life characteristic: Applied over rated power for a long time.
- \* Static electric (ESD) characteristic: Applied high-voltage momentarily.
- \* Pulse characteristic: Applied several times of voltage for a short time.

(1). Over-load life characteristic

Resistance value changing model of over-load life characteristic of thick-film chip resistor is shown in Fig.15.

Fig.15. Resistance value changing model of over-load life characteristic of thick-film chip resistor

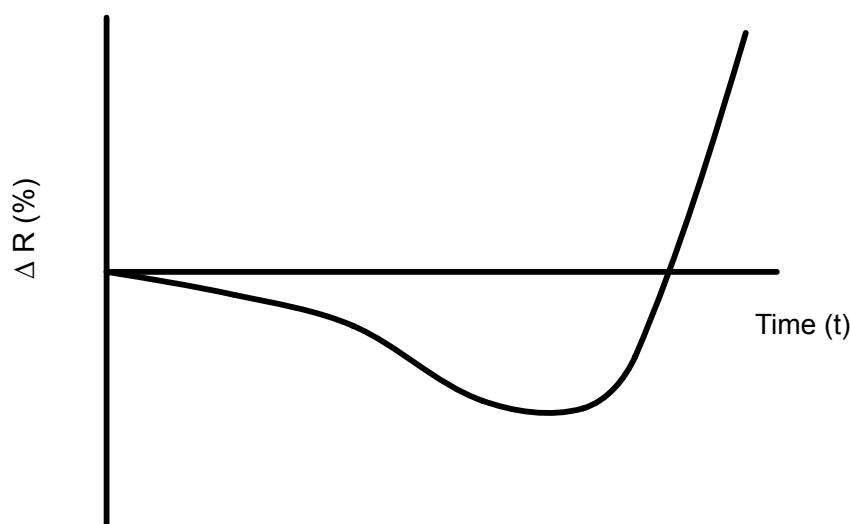

As shown in Fig.15, if impressed in the state of over-load for a long time, decreasing part of insulation resistance in the resistor occur, and resistance value continues decreasing. However, if it is still continued applying, electric current starts to concentrate in that part, decreasing of insulation resistance accelerates and resistors destroy by joule heat, resistance value start to rise, finally, come to be disconnection.

Regarding our thick-film chip resistor, as shown in table-2, the electric power guarantee that carried out the one rank rise of the conventional rated electric power.

Table-2 Power-up assurance of thick-film chip resistors

Shape	Size	Rated power
ERJ3G	1608	1/16W→1/10W
ERJ6G	2012	1/10W→1/8W
ERJ8G	3216	1/8W→1/4W

However, since the temperature of soldering part may serves high temperature by generation of heat by load depending on ambient temperature when there is no

resistance value change if electric power is impressed in the state of over-load for a long time, sufficient reliability check is required.

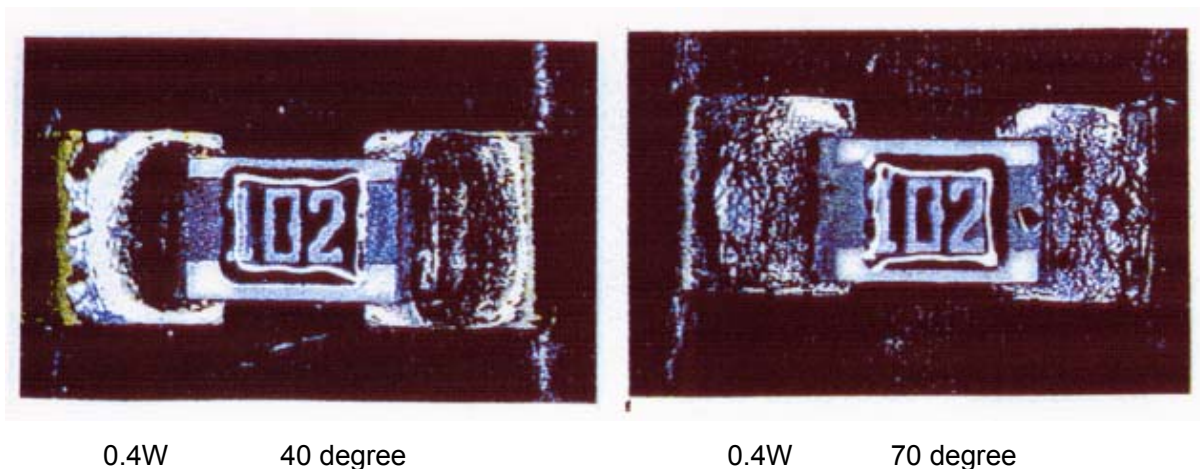

Fig.16. Reliability deterioration of soldering part in long time over-load

(2). Static electricity characteristic

In thick-film chip resistors, correlation with length of L-size and W-size of resistor and changing rate of resistance value when ESD voltage is impressed is shown in Fig.17.

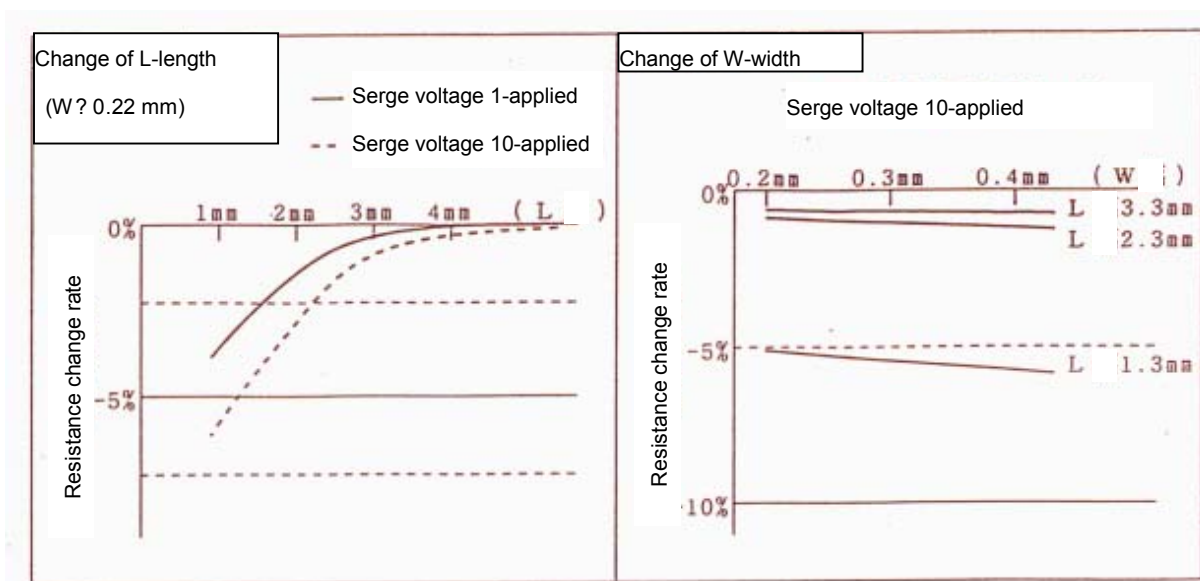

Fig.17. Correlation with L-size, W-size of thick-film chip resistor and ESD characteristic

From Fig.17, ESD characteristic is greatly influenced by termination interval. Therefore, resistance value by ESD characteristic tends to become large following on becoming small. Moreover, it is influenced by conductive mechanism of resistive material, resistance value trends to be influenced with the range from 100 ohms to 100k ohms, and the ESD characteristic is hard to be influenced by ESD in the domain where resistance value is lower than that range or a high domain.

As reference, ESD characteristic of ERJ3G-type (1608-size) is shown in Fig.18.

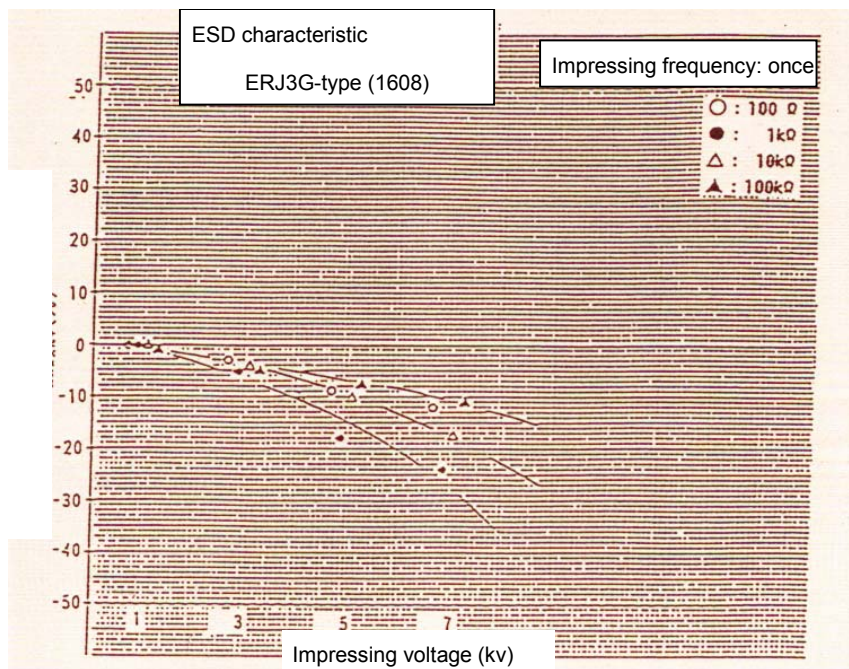
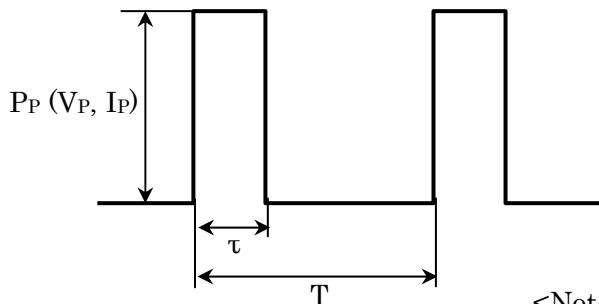

Fig.18. ESD characteristic (ERJ3G-type)

(3). Pulse characteristic

Regarding the pulse characteristic of thick-film chip resistors, examination for the contents shown below is required.

Pulse limit power ( $P_P$ ), Pulse limit voltage ( $V_P$ ) and Pulse limit current ( $I_P$ ) shall be calculate by the following formula.



- $\tau$  : Pulse continuous time (s)
- T : Pulse period (s)
- P : Rated power (W)
- $V_R$  : Rated voltage (V)
- $I_R$  : Rated current (A)
- R : Normal resistance value ( $\Omega$ )
- $V_{Pmax}$  : Max. pulse limit voltage (V)

<Note>

- \*  $T > 1$  (s)  $\rightarrow T = 1$  (s)
- \*  $T / \tau > 100 \rightarrow T / \tau = 100$
- \*  $P_P (V_P, I_P) < P (V_R, I_R)$   
 $\rightarrow P (V_R, I_R)$  stands for  $P_P (V_P, I_P)$
- \* The voltage which can be added is less than  $V_{Pmax}$ .
- \* Judgement : Resistance change  $\pm 5\%$   
 (After 1000 hours)

$$P_P = K \cdot P \cdot T / \tau$$

$$V_P = \sqrt{K \cdot P \cdot R \cdot T / \tau}$$

$$I_P = \sqrt{K \cdot P \cdot 1 / R \cdot T / \tau}$$

#Constant K and  $V_{Pmax}$  shall be shown in the below table.

	Rated Power (W)	K					$V_{Pmax}$
		$\sim 10\Omega$	$10\Omega \sim$	$100\Omega \sim$	$1k\Omega \sim$	$10k\Omega \sim$	
ERJ2G	0.1	0.11	0.11	0.11	---	---	100
ERJ3G	0.1	0.18	0.18	0.18	0.15	0.12	100
ERJ6G	0.125	0.36	0.36	0.24	0.20	0.16	200
ERJ8G	0.25	0.22	0.22	0.15	0.12	0.10	400
ERJ14Y	0.5	0.22	0.22	0.15	0.12	0.10	400
ERJ12Y/12ZY	0.75	0.20	0.20	0.20	0.16	0.13	400
ERJ1WY/1TY	1.0	0.45	0.45	0.30	0.25	0.20	500



**Approximation method**

Pulse wave shall be approximated to rectangle wave form as below.

\* The discharge waveform of a capacitor.

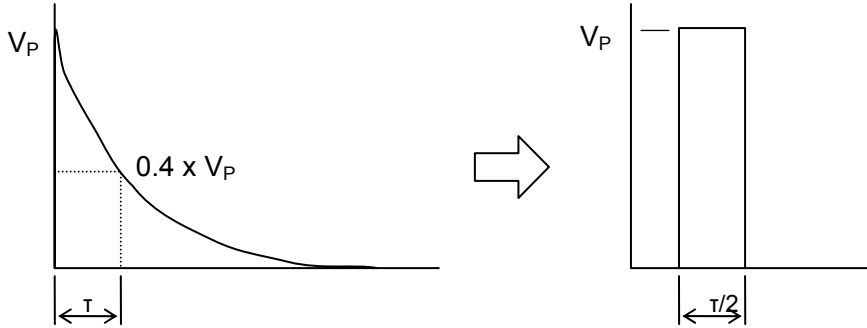

\* Sine curve

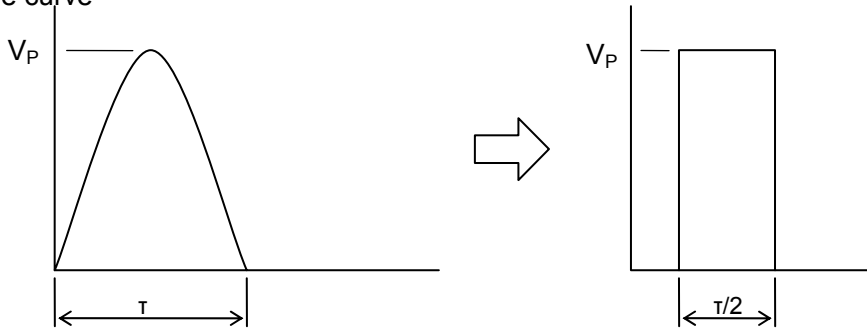

\* Triangular wave

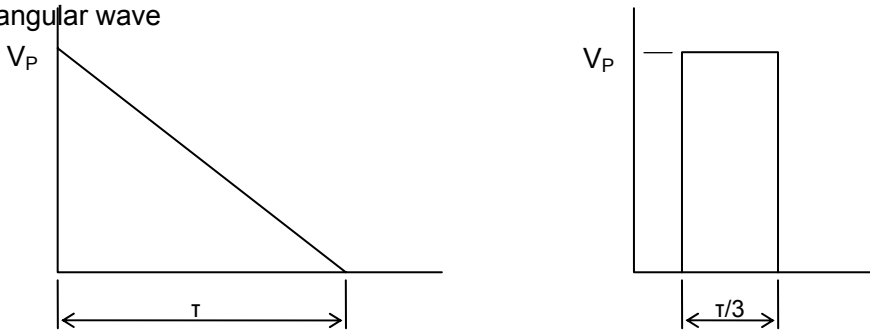

\* Special wave

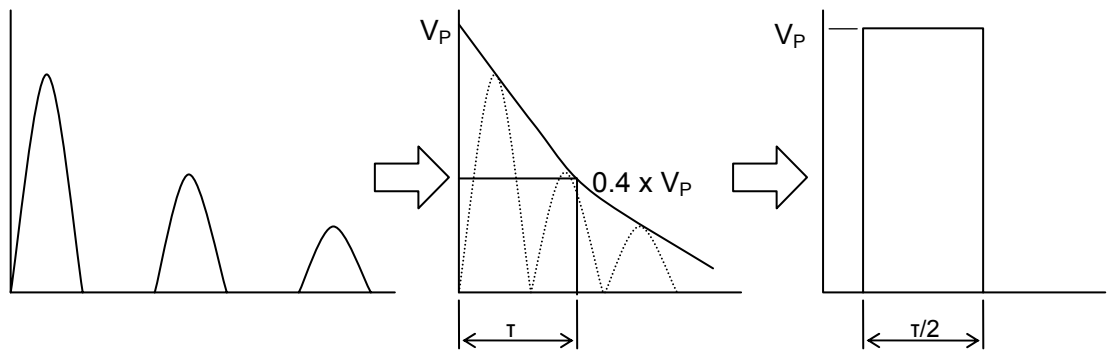

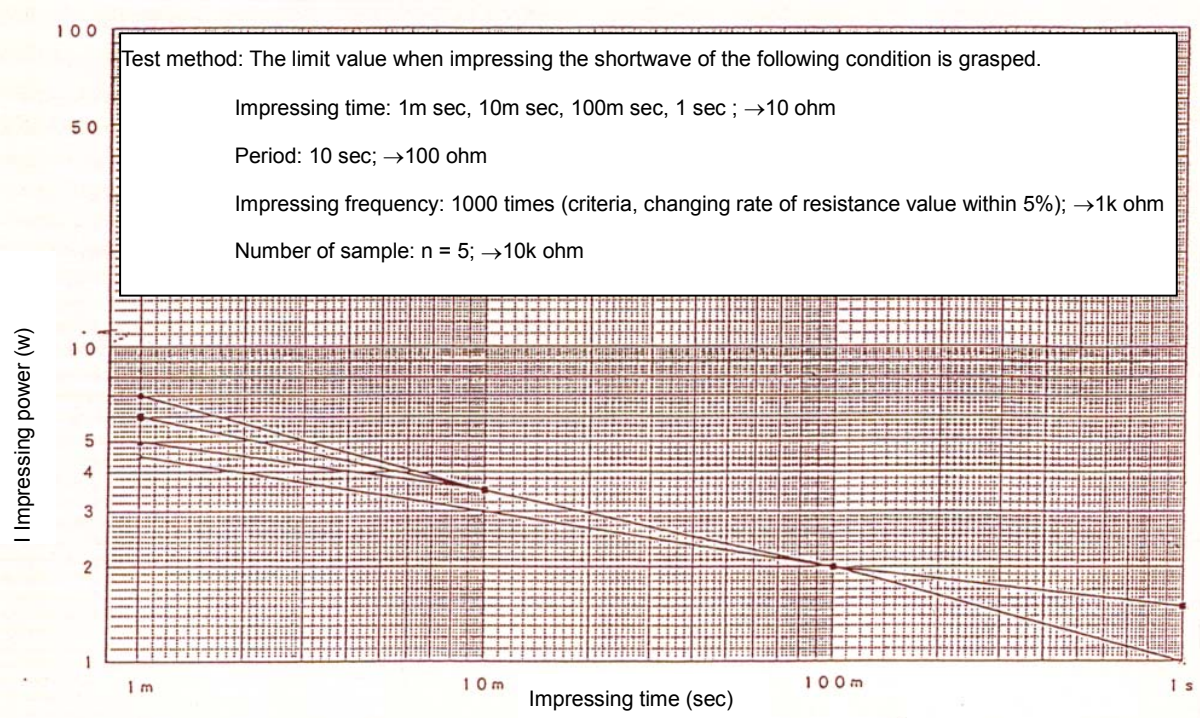

Fig.19. Pulse limited data of ERJ3G (1608)-type

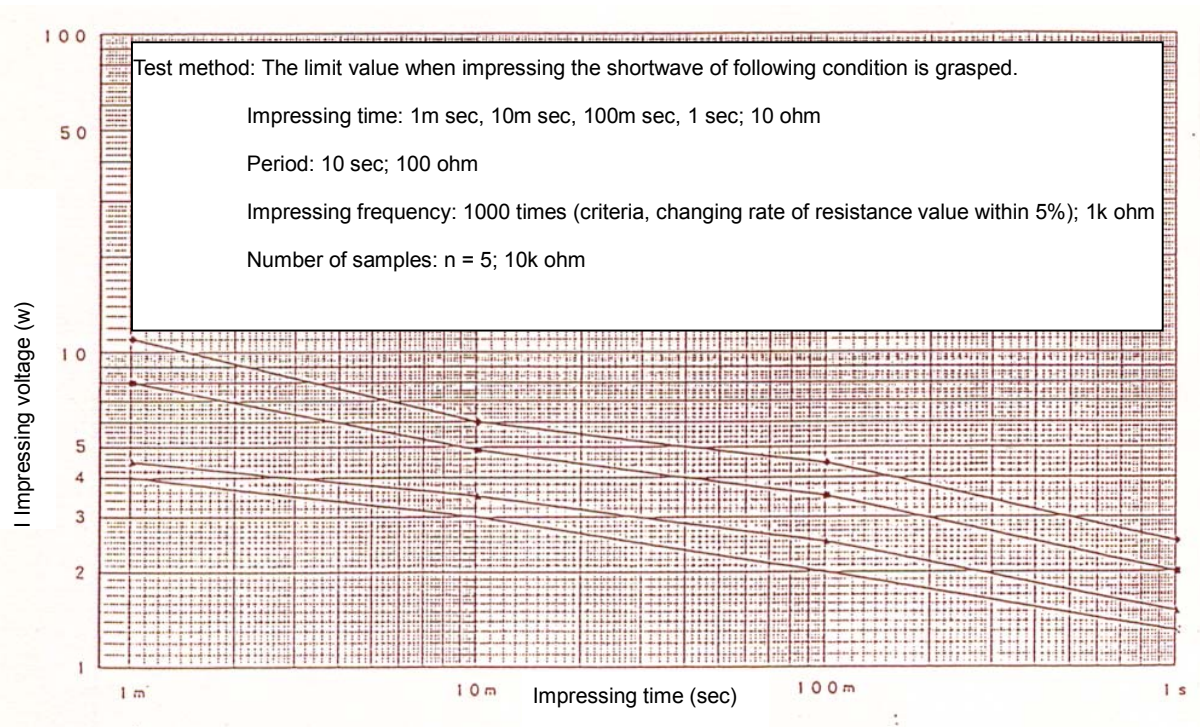

Fig.20. Pulse limited data of ERJ6G (2012)

Fig.19 and 20 is reference data to the last, and please fully perform a reliability check with your system in the use of the circuit that pulse-load is impressed.

9.2. Design of Printed Substrate

When using surface mount resistor, caring about the following point and please perform printed substrate.

9.2.1. Recommended land pattern

9.2.1.1 Chip resistors

Recommended land pattern of chip resistor by each shape is shown in Fig.21.

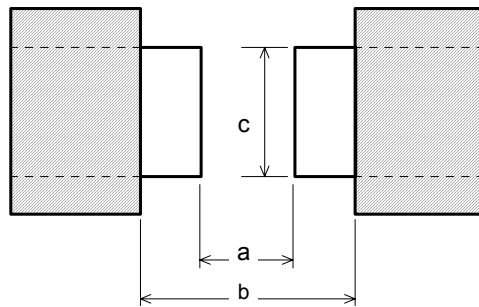

Products	Dimensions (mm)		
	a	b	c
ERJXG	0.15 to 0.20	0.5 to 0.7	0.20 to 0.25
ERJ1G	0.3 to 0.4	0.8 to 0.9	0.25 to 0.35
ERJ2G	0.5 to 0.6	1.4 to 1.6	0.4 to 0.6
ERJ3G	0.7 to 0.9	2.0 to 2.2	0.8 to 1.0
ERJ6G	1.0 to 1.4	3.2 to 3.8	0.9 to 1.4
ERJ8G	2.0 to 2.4	4.4 to 5.0	1.2 to 0.8
ERJ14	2.0 to 2.4	4.4 to 5.0	1.8 to 2.8
ERJ12	3.3 to 3.7	5.7 to 6.5	2.3 to 3.5
ERJ12Z	3.6 to 4.0	6.2 to 7.0	1.8 to 2.8
ERJ1T	5.0 to 5.4	7.6 to 8.6	2.3 to 3.5
ERJL1W	3.6 to 4.0	7.6 to 8.6	2.3 to 3.5

Fig.21. Recommended of chip resistor

9.2.1.2. Chip resistor array

Recommended land pattern of chip resistor array by each shape is shown in Fig.22.

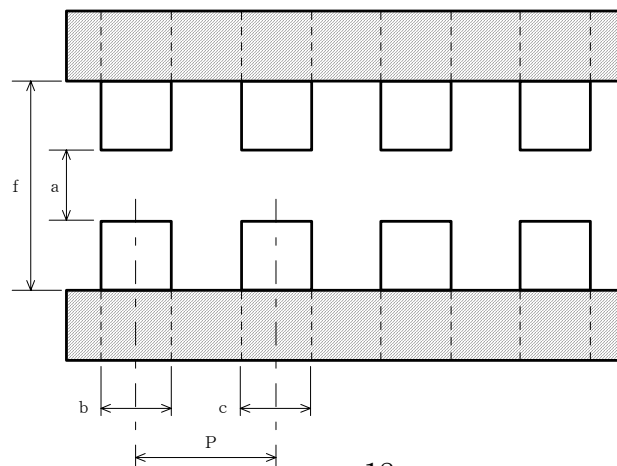

Products	Dimensions (mm)				
	a	b	c	P	f
14V	0.3	0.3	0.3	0.5	0.8 to 0.9
18V	0.2 to 0.3	0.15 to 0.20	0.15 to 0.20	0.4	0.8 to 0.9
24V	0.500	0.35 to 0.40	0.3	0.65	1.4 to 1.5
28V	0.4	0.525	0.25	0.5	1.4
N8V	0.45 to 0.50	0.35 to 0.38	0.25	0.5	1.4 to 2.0
V4V,V8V	0.7 to 0.9	0.4 to 0.45	0.4 to 0.45	0.8	2.0 to 2.4
34V,38V	0.7 to 0.9	0.4 to 0.5	0.4 to 0.5	0.8	2.2 to 2.6
S8V	1.0 to 1.2	0.5 to 0.75	0.5 to 0.75	1.27	3.2 to 3.8
2HV	1.0	0.425	0.25	0.5	2.00

Fig.22. Recommended land pattern of chip resistor array

9.2.1.3. Chip resistor network

Recommended land pattern of chip resistor network by each shape is shown in Fig.23.

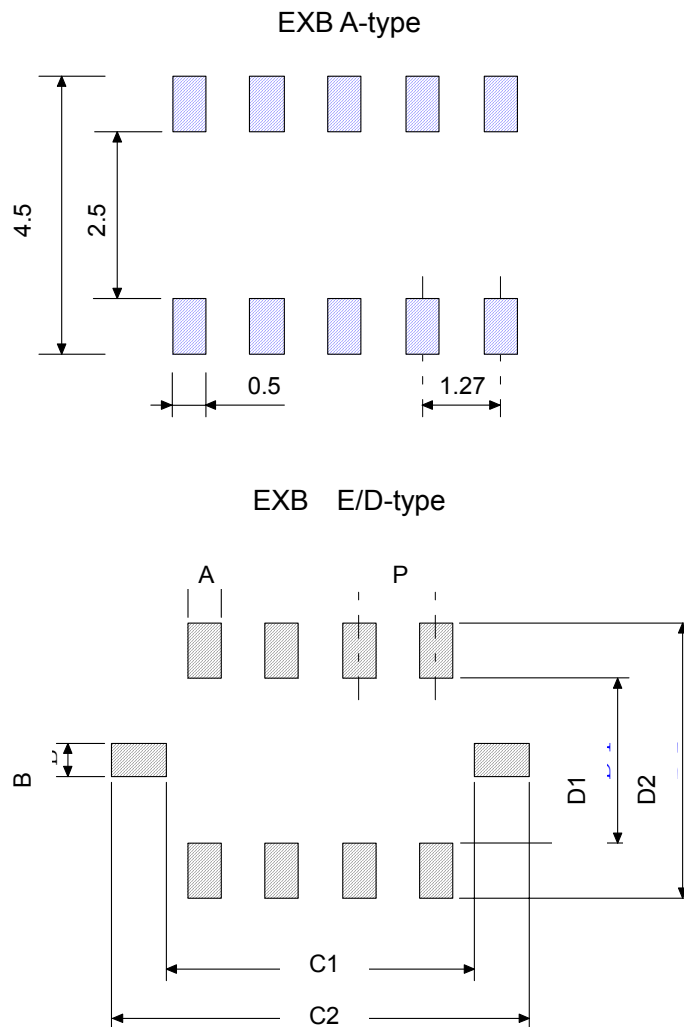

Products	A	B	C1	C2	D1	D2	P
EXBE	0.4	0.5	3.1	5.1	1.5	3.5	0.8
EXBD	0.3	0.4	2.65	4.15	0.9	2.6	0.635

Fig.23. Recommended land pattern of chip resistor network

9.2.2. Components arrangement

Since the stress to the curvature or bending at the time of breaking printed substrate may cause fault when arranging surface mount resistor near printed substrate breaking point, consideration is required for the method of arrangement of surface mount resistor. Arrangement method when arranged surface mount resistor near the breaking part of substrate is shown in Fig.24.

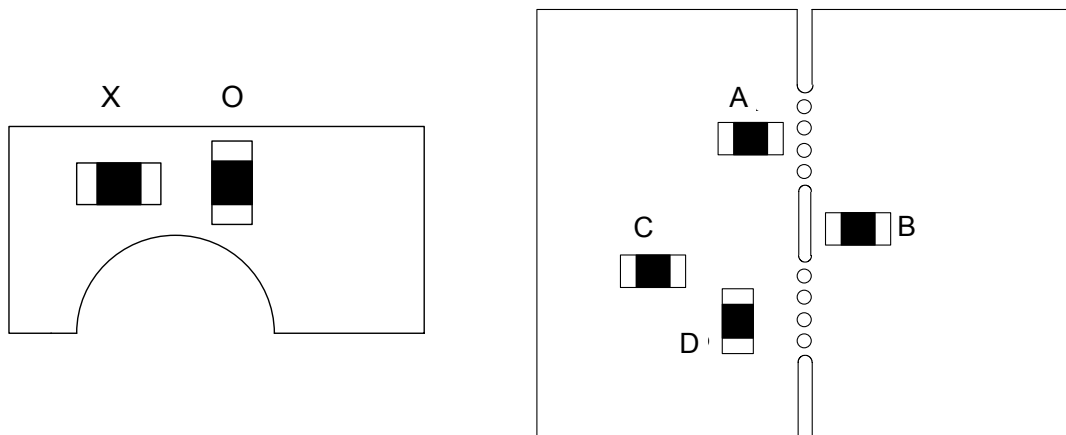

Fig.24. The caution when attaching to the place is easy to bend

The probability that surface mount resistor will break by stress when substrate break is followed below.

$$\underline{A > C > B \text{ (near infinite) } D}$$

Therefore, arrange to the break line of printed substrate as in parallel as possible, or keep away from break line as much as possible.

9.3. Used environment

Please consider enough and use under the following environment for it especially, to the environment in the case of using surface mount resistor.

9.3.1. Anti-gas characteristic of chip resistor (sulfurated atmosphere)

In the case of thick-film chip resistor that is used the material of Ag-system as inner termination, sulfurated gas invades from the space between a protective-film and plating in atmosphere, such as sulfurated gas (it is possible to occur by heat-stress while mounting), and there is rarely case that inner termination of Ag-system cause disconnection, from a reaction as shown in the following chemical formula progressing.

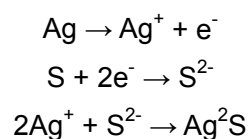

The reaction velocity in this case is influenced by sulfurated gas density, temperature and humidity greatly.

As especially the factor of sulfurated atmosphere, there are cases, rubber that is used sulfur as vulcanization, and sulfur-chlorination or sulfur oil is used in heat and

high-humidity atmosphere.

appearance and cross-sectional picture when inner termination of Ag-system is influenced by sulfuration are shown in Fig.25.

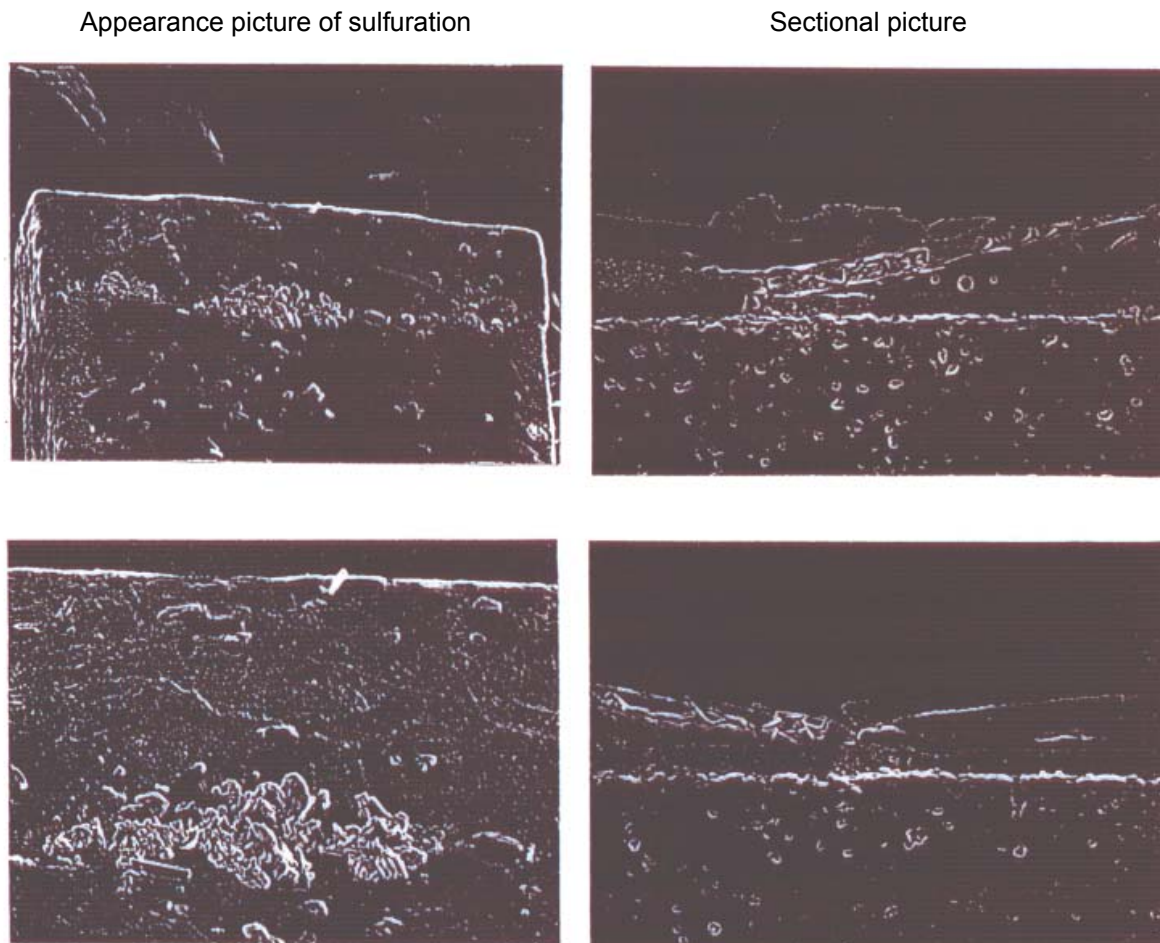

Fig.25. Sulfurated effect for chip resistor

### 9.3.2. Resin mold of chip resistor

In using resin mold of the resistor, the protective-film of resistor may exfoliate, the crack in a solder joint point may occur by the stress at the time of mold resin hardening or resistance value change and disconnection may be generated under the influence of the ingredient contained to the resin (to be mold), please fully perform reliability evaluation.

The example which the crack is generated in the solder joint part by stress at the time of resin mold are shown in Fig.26.



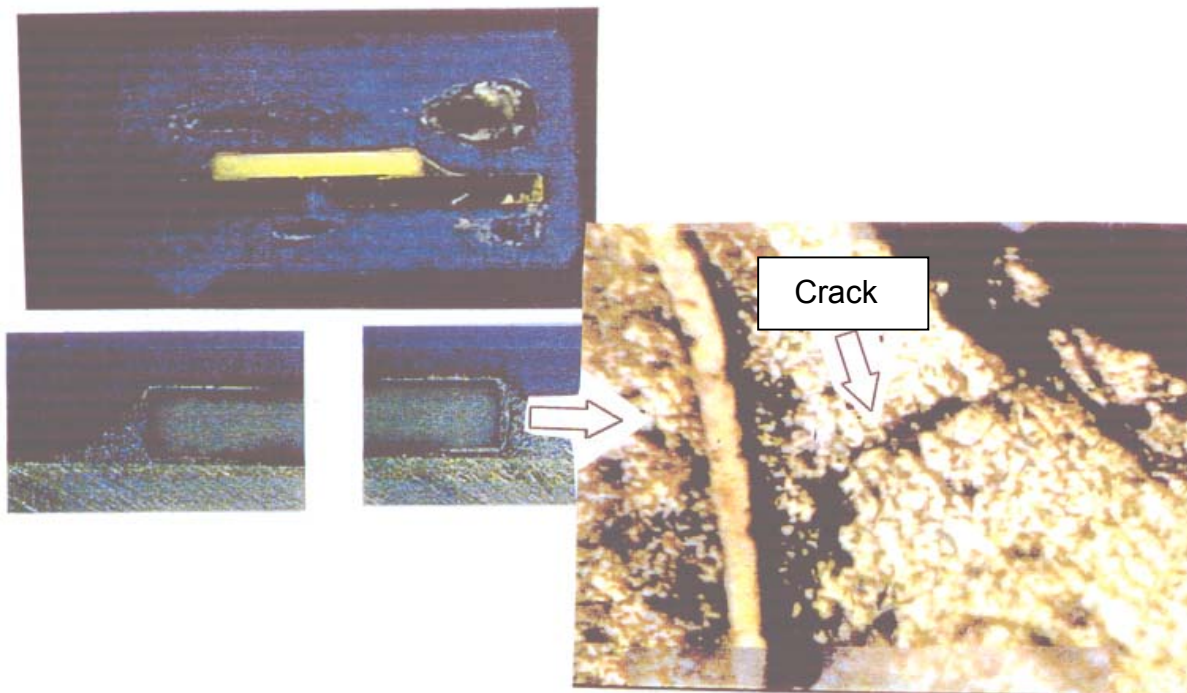

Fig.26. Disconnection by resin mold of chip resistors

9.4. Mounting quality

Please use surface mount resistor in consideration of the following contents to the method of mounting in a printed substrate, and the washing method after mounting.

9.4.1. Soldering method

Since the manhattan phenomenon at the time of exfoliation of upper surface termination or mounting may occur when it mounts two or more parts in a common land pattern, be careful for separating land pattern by solder resist and the amount of solder beyond necessity not to adhere.

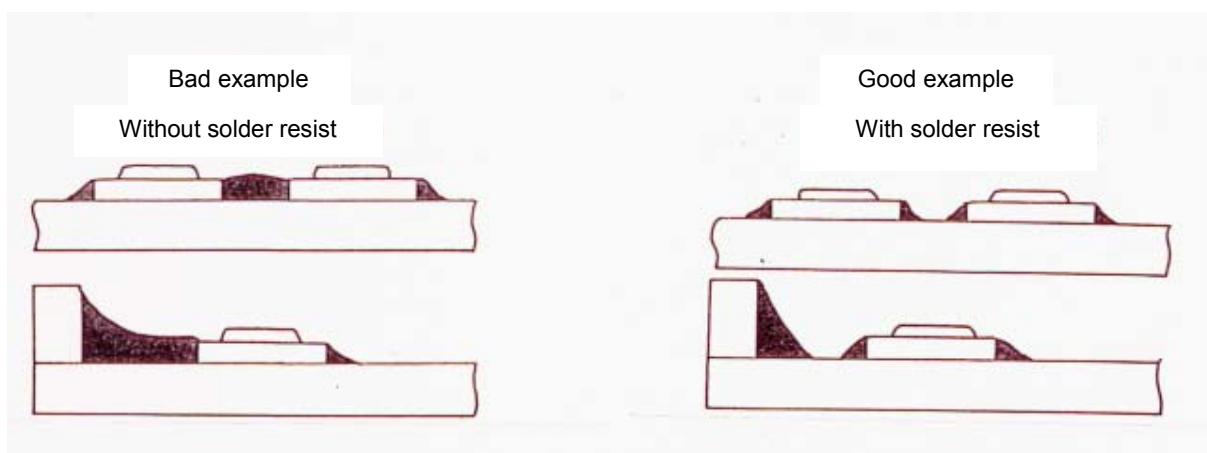

Fig.27. The mounting method in common land

Moreover, in mounting surface mount resistor in narrow pitch, in order to suppress generating of a solder ball, it recommends the solder cream that is used the solder of the shape of a delicate solder ball.

In mounting of the chip resistor in narrow pitch, and mounting of chip resistor array and chip resistor network etc., with flow soldering, since the solder bridge between termination may be generated, use of reflow soldering is recommended. In addition, regarding repair of surface mount resistor, pay attention for shock for termination part by soldering iron and temperature and time of soldering iron.

Moreover, when putting a resistor with tweezers etc., the consideration to not giving a shock to protective coating and shock to soldered termination is required.

9.4.1. The limit of resistance to soldering heat

The limit of resistance to soldering heat of surface mount resistor is shown in Fig.28.

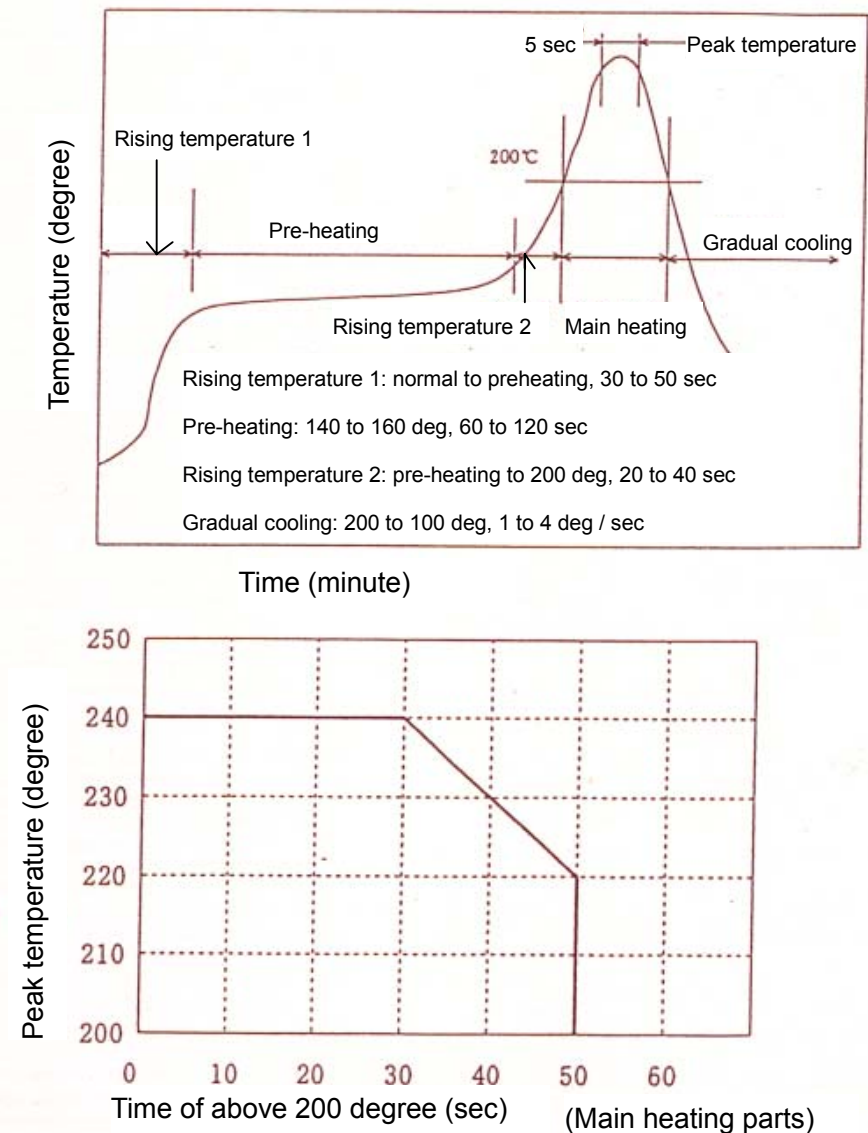

Fig.28. The limit of resistance to soldering heat of surface mount resistor

Please setup of the soldering profile by the within the limita of Fig.28.



9.4.1. Washing method

Although the fron detergent has been conventionally used for washing of a mounting base widely, it is difficult for an ozone layer depletion problem to use. Therefore, although the cases changed in this opportunity by reexamination of flux material or a reliability evaluation into no washing have increased in number in general market, the case changed into a fron-alternative detergent in part is also seen.

Principal fron-alternative detergent and characteristic are shown in table-3.

Table-3 Principal fron alternative detergent and characteristic

Classification			Primary detergent (and maker)	washing power			Reliability		New of flux	Safety		Ozone destruction	
				Ion residue	Anti-ion residue	Part (space)	Parts damage	washing residue		Flashing	Harmful		
Water	Water (pure water)		(water-soluble for flux)	A	B	B	A	A	C	A	A	A	
	Water-soluble detergent	Surfactant	Detergent: A, B, C, D, E	A	A	B	B	B	A (to B)	A (to B)	A (to B)	A	
		Alkali	Detergent: F	A	A	B	B	B	A	A	A	A	
Solvent	Semi-water	Hydrocarbon	natural oil	Detergent: G	A	A	A	B	B	A	B	A	
				Detergent: H, I	B	A	A	B	B	A	B	B	A
	Anti-semiwater		Hydrocarbon (oil)	Detergent: J, K, L	B	A	A	B	A	A	B	B	A
			Alcohol	Detergent: IPA Ethanol	B	A	B	A	A	B	B	A	A
			Silicon	Detergent: M	B	A	B	B	B	A	B	B	A
			HCFC	Detergent: N O	B	A	A	A	A	B	A	C B C	B C
Reference	Fron (CFC-113)		Detergent: P, Q	B	A	A	A	A	A	A	B	C	

A → Excellence                      C → Problem

B → Some problem

Evaluation method of anti-washing and its condition are shown in table-4, anti-washing characteristic of principal fixed resistor and fron-alternative detergent is shown in table-5.

From table-5, regarding the washing nature of chip fixed resistor, it is comparatively good. However, table-4 is reference data to the last, and performs fully reliability check with your system in actual use.

Table-4. Evaluation method of anti-washing and its condition

Washing (substrate attachment state)		→	Reliability test
Pure water	Ultrasonic washing→Drying (normal (temperature) 5 min)→(110 deg, 30 min)		Life test in humidity (1000 hours, etc) The catalog test conditions for every parts are centers. In part, others are also carried out)
IPA	Ultrasonic washing→Drying (normal, 5 min)→(110 deg, 30 min)		
Detergent; A B E	Ultrasonic washing (60 deg, 5 min) → Rinse (normal, running water; 2 min, pure water; 1 min) → Drying (110 deg, 30 min)		
Detergent; J	Ultrasonic washing (60 deg, 5 min)→ Rinse (IPA 1min)→ Drying (110 deg, 30 min)		
Detergent; G	Ultrasonic washing (normal), 5 min) → Rinse (normal, running water; 2 min, pure-water; 1 min) → Drying (110 deg, 30 min)		
Detergent; M	Ultrasonic washing (FRW-17: 40deg, 5 min)→ Rinse (FRW-1; normal, 2 min)→ Drying (FRV-1; 100 deg, 2 min)		

Note1) Although ultrasonic wave are the following conditions, some parts are immersed.  
 Techno care; 15v / l, 28KHz, Others; 6v / l, 28 to 45 to 100KHz swing  
 Note2) Heat-resistance low parts are dried at 80 deg, for 30min.  
 Note3) Using flux is RA-grade, water-soluble is non-halogen type  
 Note4) It is carrying out without putting flux into a detergent at all.

Table-5. Anti-washing of principal fixed resistor and fron-alternative detergent

Product name	Pure water	IPA	B	A	E	J	G	M
(Fixed resistor division)								
Solid resistor	a	a	b	b	b	a	a	a
Carbon film resistor	a	a	d	d	f	f	f	f
Carbon fuse resistor	a	a	d	d	f	f	f	f
Wirewound resistor (ERF)	a	a	a	a	f	f	f	f
Metal (oxide) resistor	c	c	c	c	c	c	c	c
Thick-film chip resistor	a	a	a	a	a	a	a	a
3-terminal capacitor (with lead)	f	b	c	b	b	b	b	c
Chip 3-terminal capacitor	a	a	a	a	a	a	a	a
Thermal cut-off	f	f	f	f	f	f	f	f
Precision metal film resistor	a	a	d	d	f	f	f	f
Metal film resistor (ERO)	a	a	d	d	f	f	f	f

Product name	Pure water	IPA	B	A	E	J	G	M
(Fixed resistor division)								
Metal (oxide) fuse resistor	e	e	e	e	e	e	e	e
Thermal sensitive resistor	a	a	d	d	f	f	f	f
Wirewound resistor (ERW)*	c	c	f	f	f	f	f	f
Metal film resistor (ERX)	c	c	c	c	c	c	c	c
Network resistor (SIP-type)	f	a	a	a	a	a	a	a
Network resistor (SMD-type)	c	a	c	c	c	c	c	c
EMI filters	f	b	c	b	b	b	b	c
Chip EMI filters	f	b	c	b	b	b	c	b
Chip bead core	f	b	b	b	b	b	b	b
Capacitor network	f	b	c	b	b	b	b	c
Dew condensation sensor	f	f	f	f	f	f	f	f
Chip feed through capacitor array	a	a	a	a	a	a	a	a
MR elements	f	f	f	f	f	f	f	f

(\* → without condition of ultrasonic wave)

- a: performance, marking→OK
- b: performance→OK, marking→attention
- c: performance, marking→attention (The limit of washing condition and complete of rinse condition)
- d: unusable
- e: No assurance of washing from the former
- f: individual correspondence

As trend of surface mount resistor, those with four and its flow are greatly indicated to be, (1) the formation of small-light weight of components,

As trend of surface mount resistors, those with four and its flow in Fig.29 are greatly indicated to be (1) formation of small-light weight of components, (2) composition of components, (3) high-precision and advanced features, (4) the earth environment protection and saving resources.

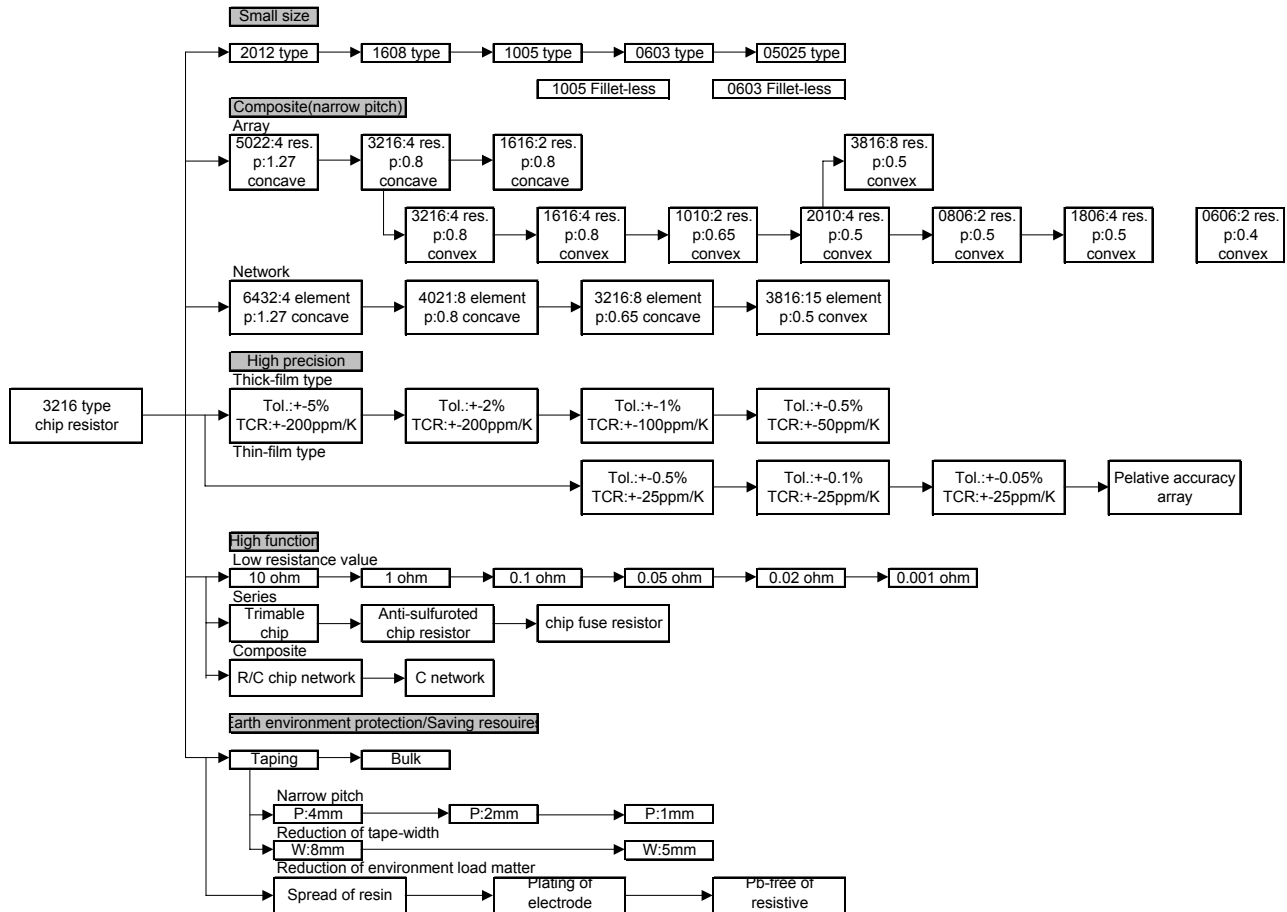

Fig.12. Trend of surface mount components

Although it becomes 0603 chip as present minimum form parts about the trend of miniaturization of parts, from the last of 93, this product began to appear in the market, and time is in a situation still required for establishment of mounting technology. Therefore, it is surmised that considerable time is required for the appearance of the further small parts. Then, the high-density mounting method is also improved fillet-less chip of 1005 chip that can make good use of mounting technique of conventional chip in a narrow chip. Furthermore, there is composition of components as method of high-density mounting. A parts interval can be lost by composition and mounting area can be made smaller the single article mounting. Naturally, also in this composition, narrow pitch is progressing (1.27 → 0.8 → 0.5 mm), from now on, a narrow pitch is accelerated to further 0.4 or 0.3 mm, and it will be surmised that the center of further high-density is borne.

As a high- precise trend, although correspondence is possible to resistance tolerance:  $\pm 0.5\%$ , TCR:  $\pm 50$  ppm / degree, with the thick-film technology, the present level presumes the limit and the high-precision product beyond this becomes a thin-film resistor, for example, resistance tolerance:  $\pm 0.1\%$ , TCR:  $\pm 25$  ppm / degree.

Moreover, chip with various functions is produced commercially in the present. For example, there are resistor for functional trimming of alternation of half-fixed resistor, chip fuse resistor with fuse function, low resistance chip with low resistance, anti-serge chip strong against serge voltage, and anti- sulfurated chip strong against sulfuration atmosphere. From now on, it is thought that series of those products will progress. Finally, the earth environment protection and saving-resources are explained. a market is considered. that the measure is advanced focusing on reduction of an environmental load substance, and waste now. About reduction of environmental load substance, the conditional examination for lead-free solder use is specially tackled. To this trend, our company is conjecturing resin of protective -film, resin of external termination and focusing on reduction of Pb and Pb-composed among environmental substances, such as Pb-free plating of external termination. This demand will become strong further, from now on. Moreover, as part of waste reduction, re-use of taping reel, narrow pitch of paper carrier-taping pitch, and packaging form also think that the change to a bulk cassette from taping etc. are accelerated.

References

- (1) “ Soldering Mount Guide Line” Panasonic Electronic Devices Co., Ltd.  
Soldering no-amendment WG
- (2) “ SMD Reliability Guide Line” Panasonic Electronic Devices Co., Ltd.
- (3) “ Fixed Resistor Technical Guide” Panasonic Electronic Devices Co., Ltd.  
Resistor Division
- (4) “ Reliability Data Book of Surface Mount Components”  
Panasonic Electronic Devices Co., Ltd.

Surface Mount Resistors  
TECHNICAL GUIDE

Published Date; First Edition    November, 1, 1999  
Publication; Circuit Components Business Unit  
Industrial Devices Company  
Panasonic Corporation

\*2012 Apr.  
Renamed to Panasonic Corporation

**Unapproved reproduction is forbidden**