

ITEM NO.	DESCRIPTION	MATERIAL	QTY.
1	Shell	C3604 Brass, nickel plated	1
2	Insulator	Nylon PA46, black	1
3	Spring contact	C5191 Phosphor bronze, nickel plated	1

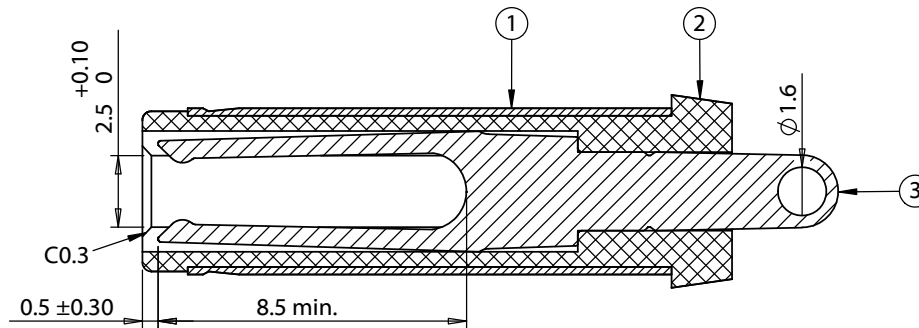

SECTION A-A
SCALE 4 : 1

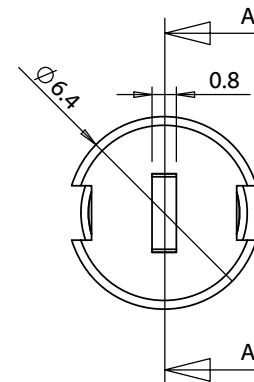
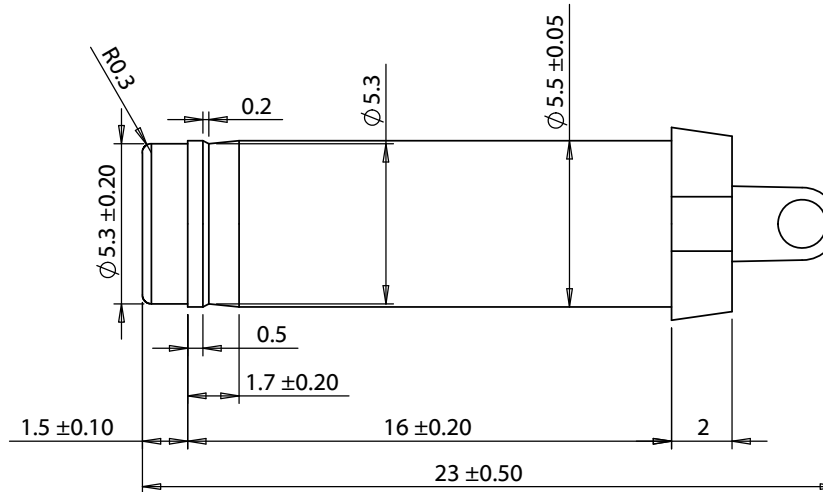
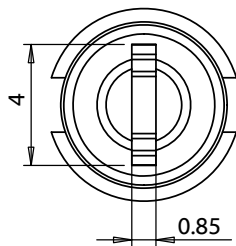

Ratings

Operating Voltage: 48 Vdc
Max Current: 10 A

Operating Temperature Range

-25° to 105° C, relative humidity of 85% or less

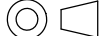
Revision:	Date:	Description:	Prepared:	Notes:	TENSILITY tel 1.541.323.3228 800 877.670.7118 fax 1.541.323.4202 web tensility.com
A	9/28/2016	Initial release	Verified:	RoHS and REACH compliant Function test: no open, no short circuit, no intermittent	
			Dimensions are in millimeters. Tolerances: X: ± 0.5 mm X.X: ± 0.3 mm X.XX: ± 0.05 mm	Description: Connector, dc plug, 5.5x2.5x23 mm, molding style, spring contacts, nickel plated, 105° C	Size: Part number: A 50-00542
					Scale: 5:1  Sheet 1 of 2

Electrical Requirements

Operating Voltage: 48 Vdc
 Max Current: 10 A
 Dielectric strength: 1 min @ 500 Vac
 Insulation resistance: 100 MΩ @ 500 Vdc
 Contact resistance: 30 mΩ or less

Mechanical Requirements

Insertion force: 0.3-3 kgf
 Withdrawal force: 0.3-3 kgf
 Life cycle: 5000 mating cycles while maintaining 0.3-2 kgf min. insertion force, 0.2-1.5 kgf min. withdrawal force and less than 100 mΩ contact resistance.

Environmental Requirements

Operating Temperature Range: -25° to 105° C, relative humidity of 85% or less
 Heat test: 70 °C, relative humidity 70-85% for 96 hours without deformation while maintaining less than 100 mΩ contact resistance and a minimum of 50 MΩ insulation resistance at 500 Vdc.
 Humidity test: 40 °C, relative humidity 90-100% for 96 hours without deformation while maintaining dielectric strength at 500 Vac for one minute, minimum insulation resistance of 50 MΩ at 500 Vdc, and a maximum contact resistance of 100 mΩ.
 Salt spray test: 35±2 °C, relative humidity 90-95%, 5% NaCl mist for 24 hrs. Wash parts after test. Maintain mechanical requirements and a contact resistance of less than 80 mΩ.

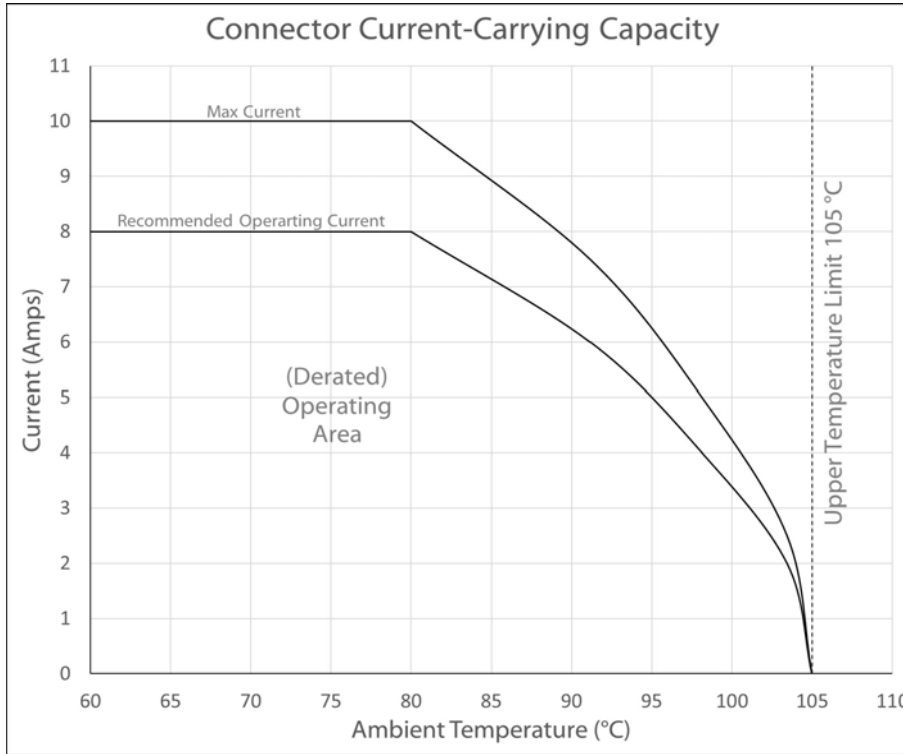

Testing based on IEC 60512-5-2. Max current curve generated with isolated test article under controlled environmental conditions, and does not take into account external factors such as housings or circuitry. Recommended operating current curve accounts for external factors, manufacturing variation, and error in temperature measurements.

Revision:	Date:	Description:	Prepared:	Notes: RoHS and REACH compliant	<h1>TENSILITY</h1> <p>tel 1.541.323.3228 800 877.670.7118 fax 1.541.323.4202 web tensility.com</p>
A	2/17/2017	Initial release	Verified:		
			Dimensions are in millimeters. Tolerances: X: ± 0.5 mm X.X: ± 0.3 mm X.XX: ± 0.05 mm	Description:	Size: Part number:
				Connector, dc plug, 5.5x2.5x23 mm, molding style, spring contacts, nickel plated, 105° C	A 50-00542
				Scale: 5:1	 Sheet 2 of 2