

Description	Material	Finish
Body	Brass	Nickel
Pin	Brass	Gold
Pin Insulator	PTFE	N/A
Washer	Brass	Nickel
Nut	Brass	Nickel
Spacer	PTFE	N/A
Shield Sleeve	Brass	Nickel
Retaining Nut	Brass	Nickel
Crimp Ring	Brass	Nickel
Heat Shrink	Polyolefin	Black

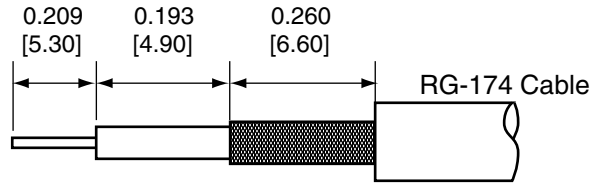

RECOMMENDED CABLE STRIPPING DIMENSIONS

REVISIONS			
REV	DESCRIPTION	DATE	APPV
B	Cable stripping dims, new spacer shape, heat shrink	11/1/10	CJ
C	Updated dimensions; Added new title block	29-JUN-12	SAH
D	Updated side view and retaining nut; Updated notes	6-AUG-18	CLL

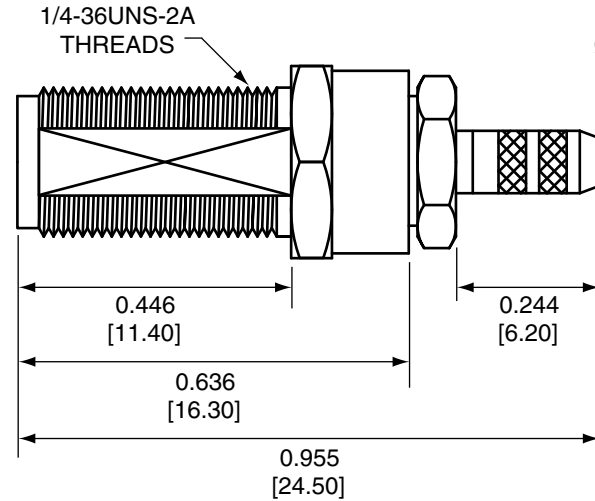
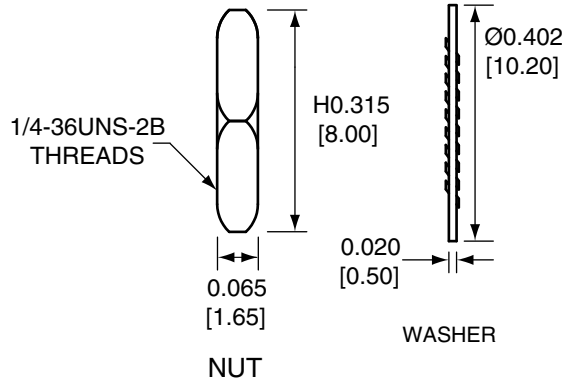

SIDE VIEW

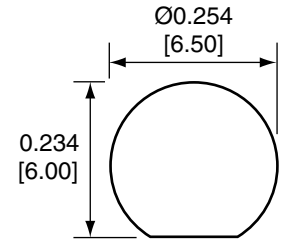
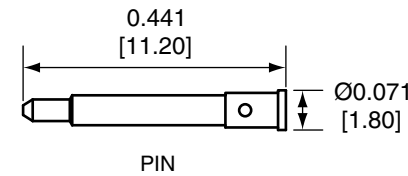
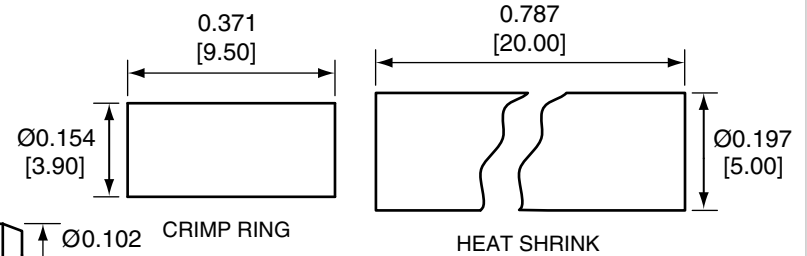

RECOMMENDED MOUNTING HOLE

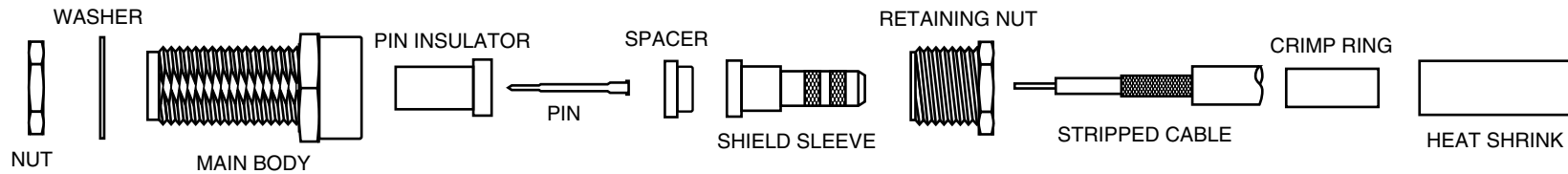

NOTES: (UNLESS OTHERWISE SPECIFIED)

- ALL DIMENSIONS ARE IN INCHES [mm].
- DIMENSIONS APPLY AFTER FINISHING.
- SAFETY BREAK ALL SHARP CORNERS AND EDGES .02 MAXIMUM.
- MANUFACTURE TO BE COMPLIANT WITH EU RoHS DIRECTIVE, USE MATERIALS THAT DO NOT CONTAIN REACH SUBSTANCES OF VERY HIGH CONCERN >1000ppm, AND USE DRC CONFLICT-FREE SOURCED MATERIALS.

CONREVSMA005 ASSEMBLY INSTRUCTIONS

- Strip cable to recommended dimensions.
- Slip heat shrink and crimp ring onto stripped cable.
- Insert the stripped cable through the retaining nut, shield sleeve, and spacer.
- Solder the pin to the center conductor.
- Insert the pin into the pin insulator, then screw the main body onto the retaining nut.
- Wrap the braid around the tail of the body and crimp the ring with a 0.128" hex crimp tool (or one labeled for use with RG-174 cable).
- Use heat shrink to cover crimp.
- Use the nut and washer to secure the connector to a case.

WARNING: THIS DRAWING CONTAINS PROPRIETARY INFORMATION THAT IS THE SOLE PROPERTY OF LINX TECHNOLOGIES, AND SHALL BE TREATED AS SUCH. NO DISCLOSURE OR REPRODUCTION OF THIS DOCUMENT IS PERMITTED, IN WHOLE OR IN PART, WITHOUT THE EXPRESS WRITTEN PERMISSION OF LINX TECHNOLOGIES OR ITS DESIGNATED AGENTS.

MATERIAL:	TOLERANCES: .020 [0.50]-.200 [5.00]= ±.008 [0.20] .200 [5.00]-1.200 [30.00]= ±.016 [0.40] 1.20 [30.0]-4.75 [120.0]= ±.024 [0.60] 4.75 [120.0]-12.40 [315.0]= ±.040 [1.0]	PROJECTION: ANGLES: ±1°
FINISH:	DRAWN: B.MURPHY DT: 29-JUN-12	ENGR: S.HOGAN DT: 29-JUN-12

Linx		159 ORT LANE MERLIN, OR 97532	
TITLE: RP-SMA FEMALE BULKHEAD MOUNT CABLE END CRIMP FOR RG174 CABLE			
SIZE A	DWG. NO. CONREVSMA005	REV D	
SCALE: 2:1	DO NOT SCALE DRAWING	SHEET 1 OF 1	