

MATERIALS AND FINISHES

BODY ZINC ALLOY  
PLATED NICKEL

CENTER CONTACT PHOSPHOR BRONZE  
PLATED GOLD/TIN

INSULATOR POLYPROPYLENE

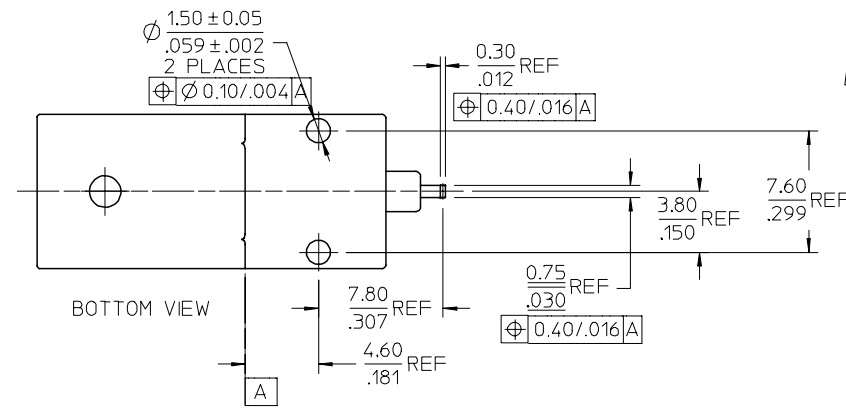
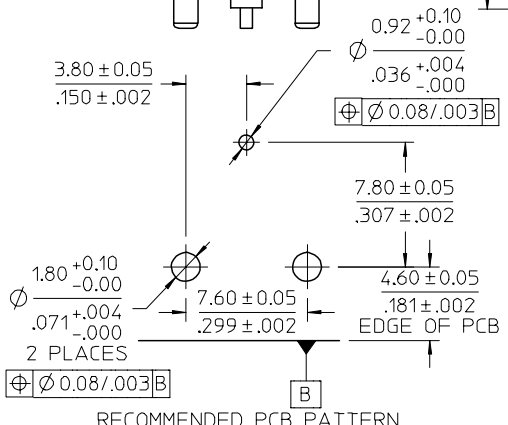
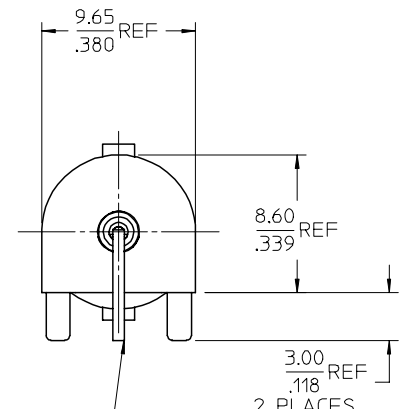
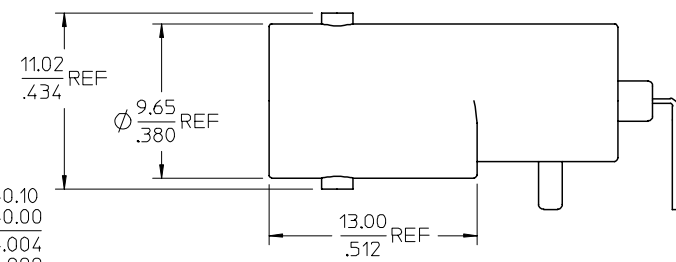
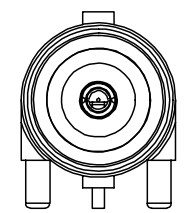
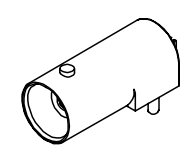
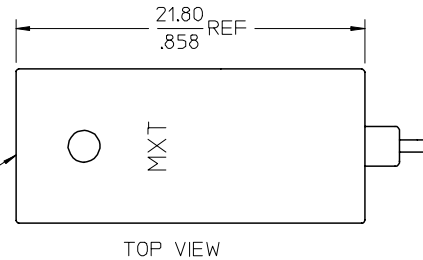

THIS LEAD IS FORMED TO FIT  
RECOMMENDED PCB PATTERN  
DURING INSTALLATION

PS-73598-0050	PRODUCT SPECIFICATION
SPECIFICATION	DESCRIPTION

73171-3150	73100-0105, ONE PER BAG
73100-0105	BULK
PART NO.	PACKAGING

CHG: REDREW IN SD  
ADDED P/N  
73100-0105

EC NO: URF 2007-0396

DRWN: FLAHERTY 2007/05/01

CHKD: SHAH 2007/05/01

APPR: JIMENER 2007/05/01

REVISION DESCRIPTION

QUALITY SYMBOLS

▽=0

▽=0

GENERAL TOLERANCES (UNLESS SPECIFIED)	DIMENSION STYLE MM/IN	SCALE	DESIGN UNITS METRIC	THIRD ANGLE PROJECTION
4 PLACES ± --- ± ---	mm INCH	DRAWN BY THOMPSON	DATE 1994/09/15	TITLE BNC JACK, R/A, RECEPTACLE 50 OHMS BNC-J/RA/PCB
3 PLACES ± --- ± ---		CHECKED BY A CHANG	DATE 1994/09/15	
2 PLACES ± --- ± ---		APPROVED BY A CHANG	DATE 1994/09/15	
1 PLACE ± --- ± ---		MATERIAL NO.	DOCUMENT NO.	SHEET NO.
ANGULAR ± 2 °	SEE TABLE		SD-73100-0105	1 OF 1
DRAFT WHERE APPLICABLE MUST REMAIN WITHIN DIMENSIONS		THIS DRAWING CONTAINS INFORMATION THAT IS PROPRIETARY TO MOLEX INCORPORATED AND SHOULD NOT BE USED WITHOUT WRITTEN PERMISSION		