

DESCRIPTION: COAXIAL COMBO RIGHT ANGLE

FACE VIEW OF RECEPTACLE IS SHOWN

PART NUMBER KEY

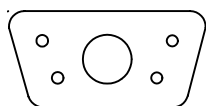

5W1

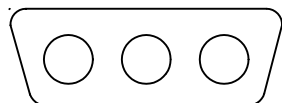

3W3

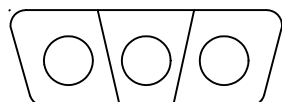

3W3K

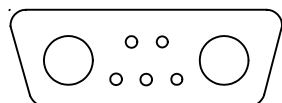

7W2

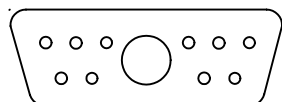

11W1

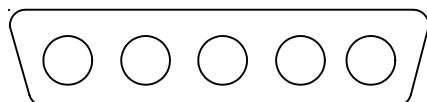

5W5

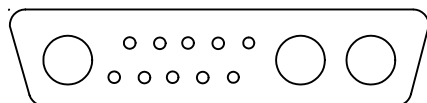

13W3

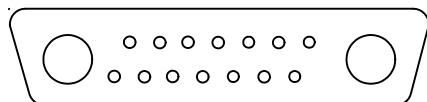

17W2

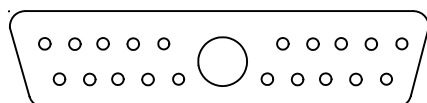

21W1

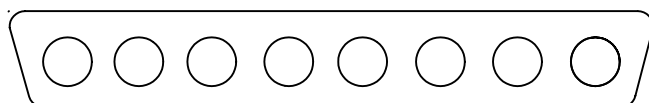

8W8

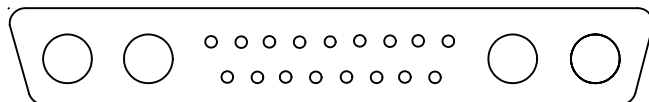

21WA4

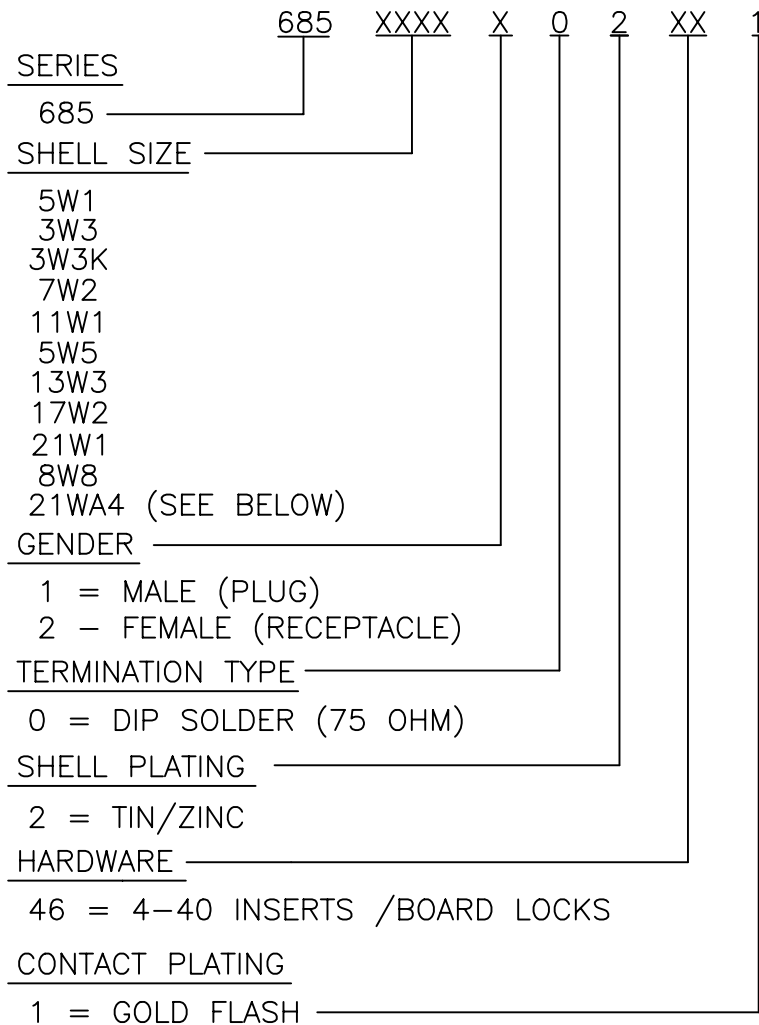

68521WA4 PART NUMBERS = 68521WA4P461 = MALE
68521WA4S461 = FEMALE



THESE DRAWINGS AND SPECIFICATIONS ARE THE PROPERTY OF NorComp AND SHALL NOT BE REPRODUCED, COPIED OR USED AS THE BASIS FOR THE MANUFACTURE OR SALE OF APPARATUS WITHOUT WRITTEN PERMISSION.

DRAWN: PAM JENKINS

DATE: 6-3-02

CHECKED:

DATE:

NorComp

SCALE: SHEET 1 OF 1 REV 2

DWG NO. 685 SERIES CONNECTORS

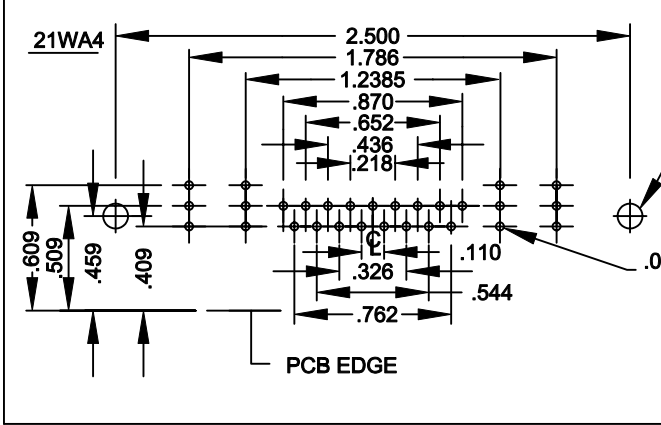
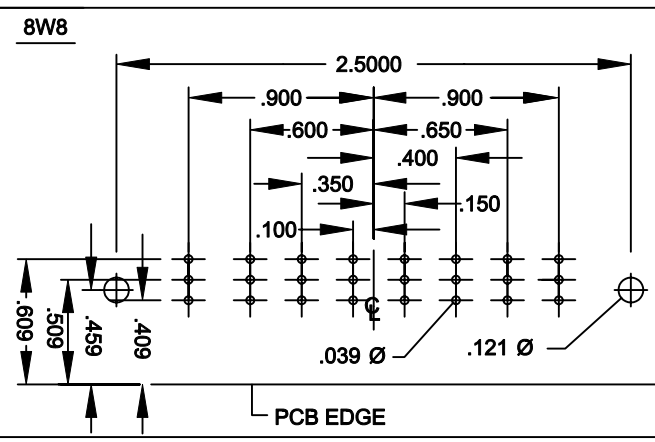
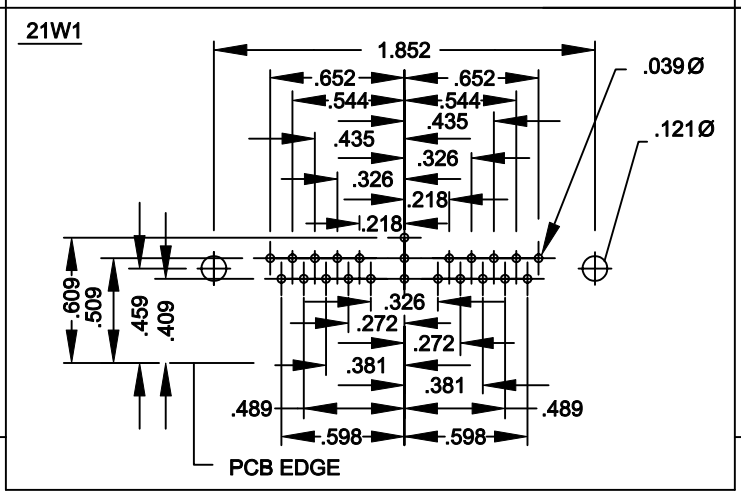
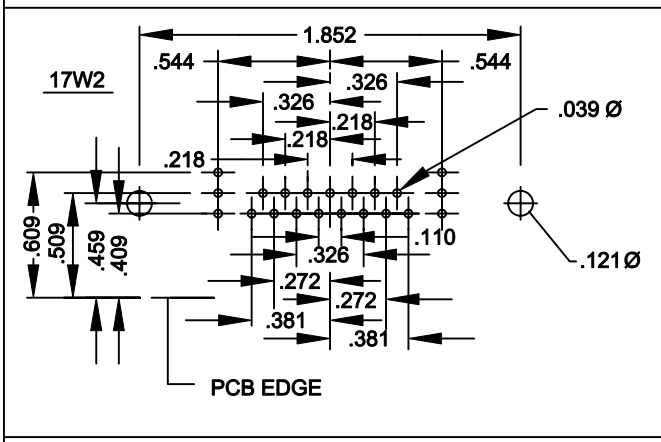
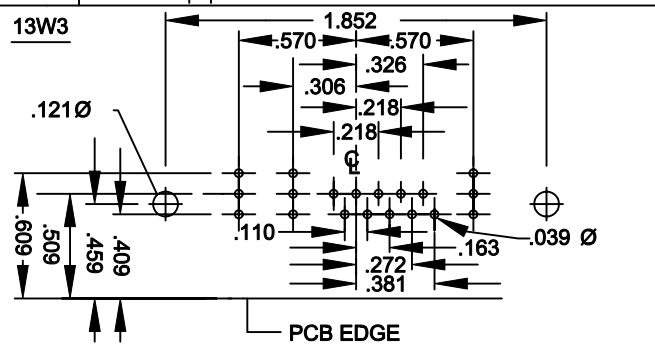
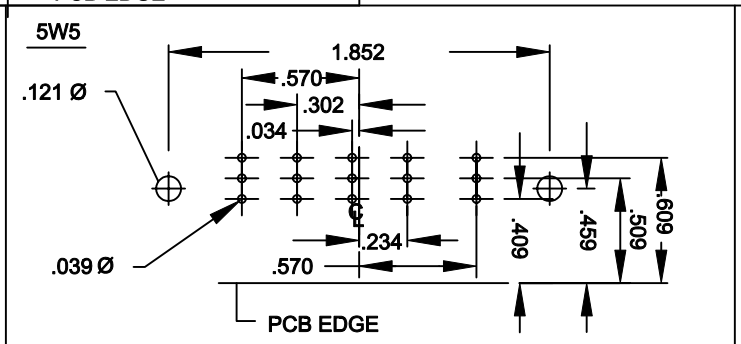
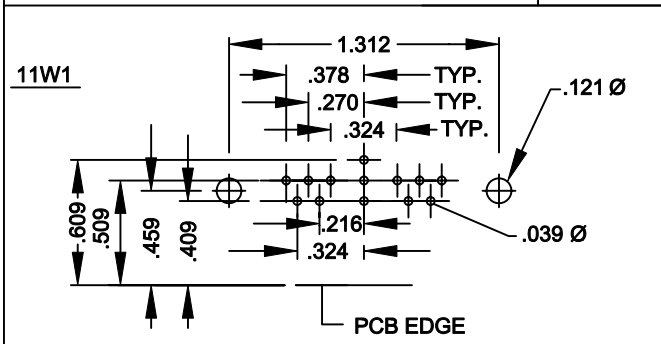
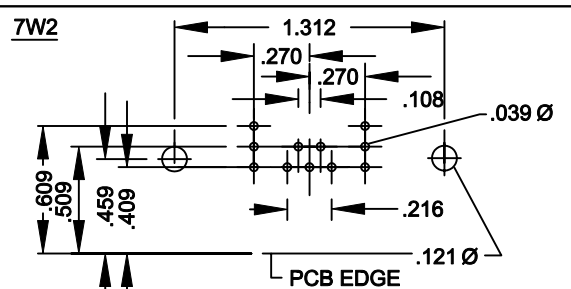
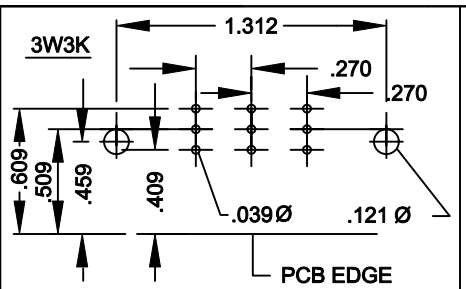
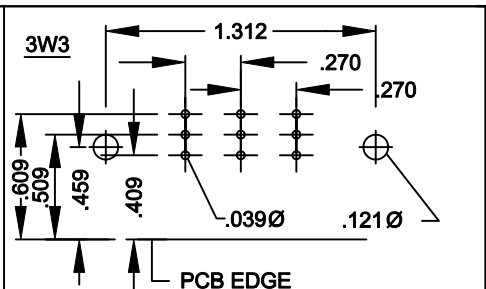
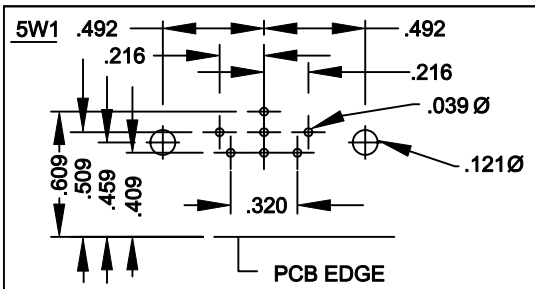

	THESE DRAWINGS AND SPECIFICATIONS ARE THE PROPERTY OF NorComp AND SHALL NOT BE REPRODUCED, COPIED OR USED AS THE BASIS FOR THE MANUFACTURE OR SALE OF APPARATUS WITHOUT WRITTEN PERMISSION.		DRAWN: PAM JENKINS	DATE: 3-3-03	
			CHECKED:	DATE:	
<h1>NorComp</h1>			SCALE:	SHEET 1 OF 1	REV 2
			DWG NO. 685 Series Male Footprints		

DESCRIPTION: SIGNAL/COAXIAL CONTACTS

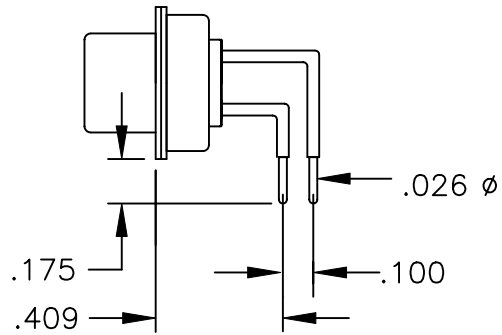

SIGNAL CONTACTS

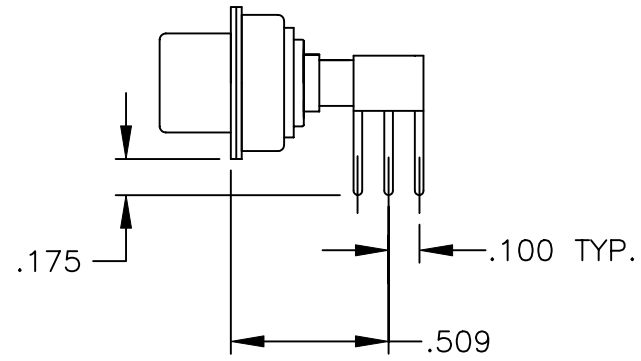

75 OHM COAXIAL CONTACTS

MOUNTING HARDWARE

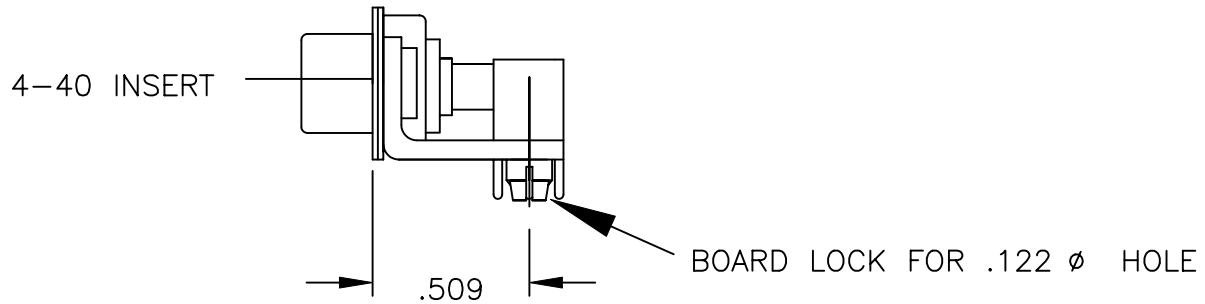

NOTE: SIGNAL AND POWER CONTACTS COME PRE-LOADED INTO INSULATOR.

	THESE DRAWINGS AND SPECIFICATIONS ARE THE PROPERTY OF NorComp AND SHALL NOT BE REPRODUCED, COPIED OR USED AS THE BASIS FOR THE MANUFACTURE OR SALE OF APPARATUS WITHOUT WRITTEN PERMISSION.		DRAWN: PAM JENKINS	DATE: 6-5-02
	<h1>NorComp</h1>			CHECKED:
SCALE:				SHEET 1 OF 1
DWG NO. 685 XXXX X 0 2 461				

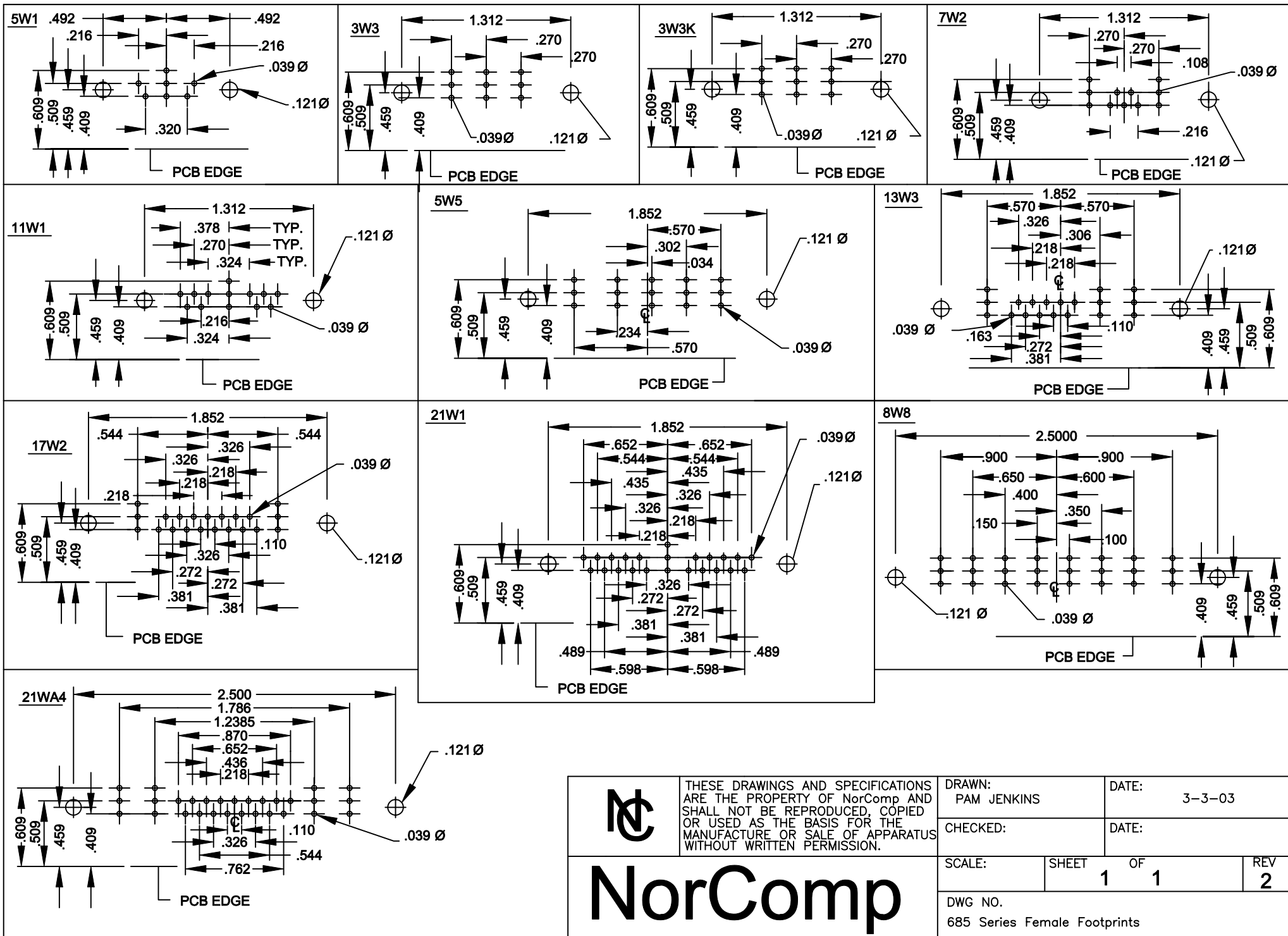

	THESE DRAWINGS AND SPECIFICATIONS ARE THE PROPERTY OF NorComp AND SHALL NOT BE REPRODUCED, COPIED OR USED AS THE BASIS FOR THE MANUFACTURE OR SALE OF APPARATUS WITHOUT WRITTEN PERMISSION.		DRAWN: PAM JENKINS	DATE: 3-3-03
			CHECKED:	DATE:
<h1>NorComp</h1>		SCALE:	SHEET 1 OF 1	REV 2
		DWG NO. 685 Series Female Footprints		