

No. OF PINS	DIMENSIONS							
	A	B	C	D	E	F	G	H
15	1.213	0.984	0.666	0.329	0.090	0.756	0.496	0.429
	30.80	24.99	16.92	8.36	2.29	19.20	12.60	10.90
26	1.541	1.312	0.970	0.329	0.090	1.091	0.496	0.429
	39.15	33.32	24.65	8.36	2.29	27.70	12.60	10.90
44	2.087	1.852	1.512	0.329	0.090	1.618	0.496	0.429
	53.00	47.04	38.40	8.36	2.29	41.10	12.60	10.90

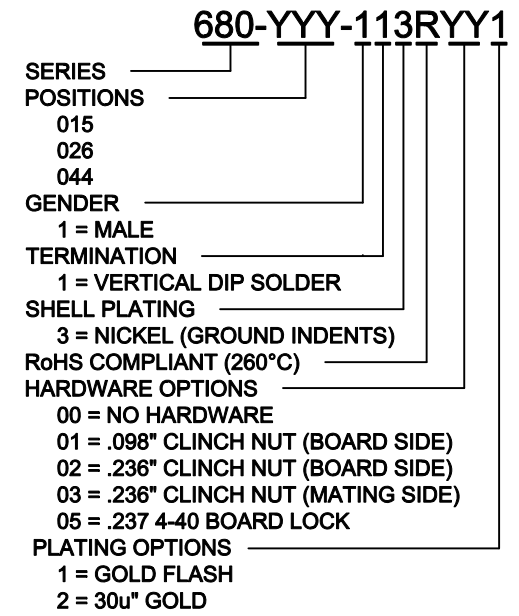
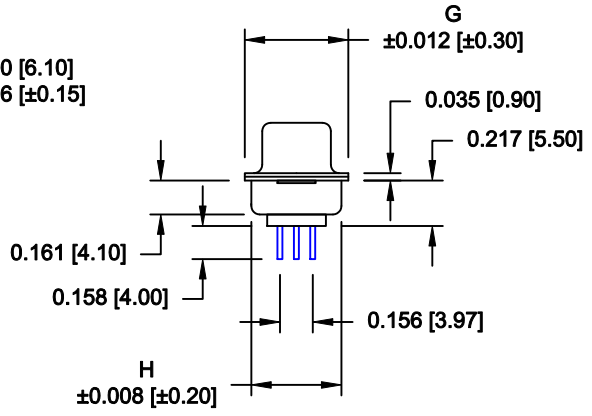
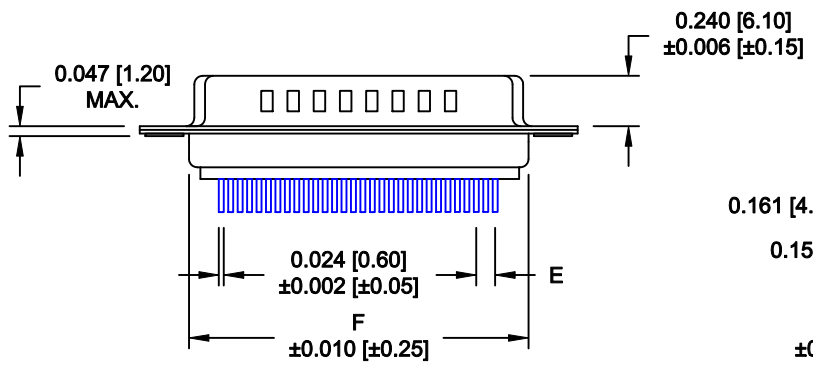

**MATERIAL:**

- SHELL: STEEL, NICKEL PLATED
- INSULATOR: PBT, UL 94V-O RATED, +30% FIBER-GLASS OR NYLON-66
- CONTACT: BRASS, GOLD PLATED OVER NICKEL
- SEALING MATERIAL: F08 FLEXIBLE ADHESIVE

**ELECTRICAL:**

- CURRENT RATING: 5 AMPS
- CONTACT RESISTANCE: 15 mOhms Max.
- INSULATION RESISTANCE: 1,000 MOhms min.
- VOLTAGE: 500VAC FOR 1 MINUTE
- TEMPERATURE: -50° C TO 100° C

**MEETS IP66 STANDARDS**  
(SEE PAGE 4 FOR SEALING DETAILS)

**DO NOT SCALE FROM DRAWING**

**RoHS COMPLIANT**

	THESE DRAWINGS AND SPECIFICATIONS ARE THE PROPERTY OF NorComp AND SHALL NOT BE REPRODUCED, COPIED OR USED AS THE BASIS FOR THE MANUFACTURE OF SALE OF APPARATUS WITHOUT WRITTEN PERMISSION.		DRAWN: <b>M. SIGMON</b>	DATE: <b>08-23-11</b>
			CHECKED:	DATE:
		SCALE: <b>1 : 1</b>	SHEET <b>1</b> OF <b>4</b>	REV <b>1</b>
		DWG NO. <b>680-YYY-113RYY1</b>		

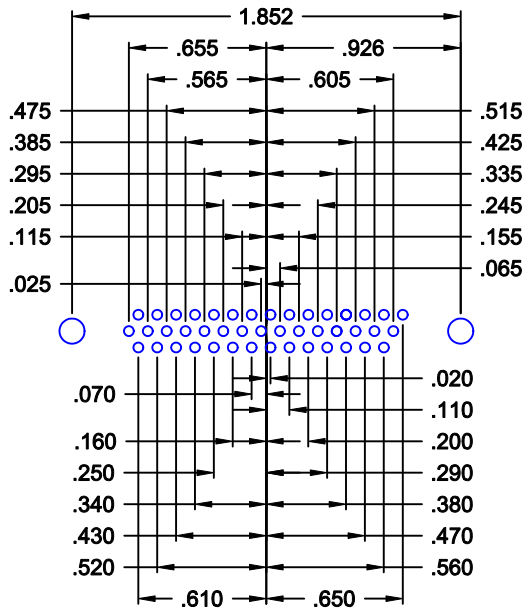
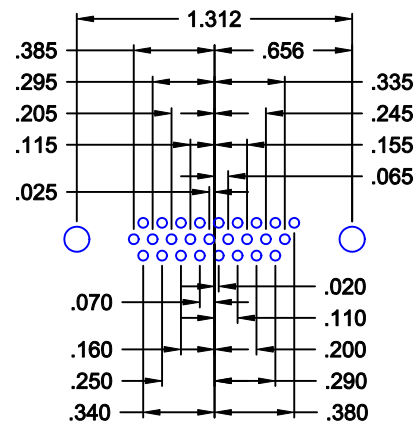
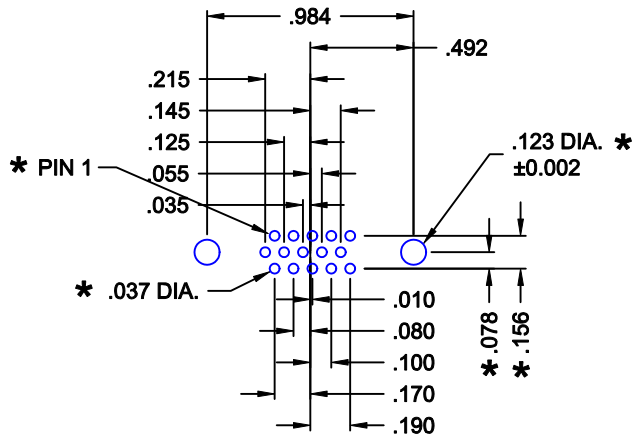

180 SERIES  
HIGH DENSITY  
VERTICAL

HOLE PATTERN SHOWN  
ARE FOR MALE

\* TYP. ON ALL SIZES

DO NOT SCALE FROM DRAWING

	THESE DRAWINGS AND SPECIFICATIONS ARE THE PROPERTY OF NorComp AND SHALL NOT BE REPRODUCED, COPIED OR USED AS THE BASIS FOR THE MANUFACTURE OF SALE OF APPARATUS WITHOUT WRITTEN PERMISSION.		DRAWN: <b>M. SIGMON</b>	DATE: <b>08-23-11</b>
			CHECKED:	DATE:
<h1>NorComp</h1>		SCALE:	SHEET <b>2</b> OF <b>4</b>	REV <b>1</b>
		DWG NO. <b>680-YYY-113RYY1</b>		

**ALL CLINCH-NUTS ARE 4-40 INTERNAL THREADS**

01X ..... 0.098" (BOARD SIDE) - CN1

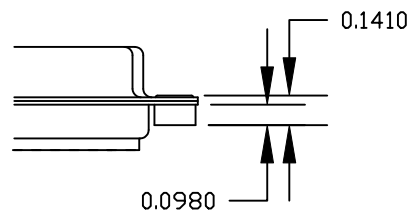

02X ..... 0.236" (BOARD SIDE) - CN2

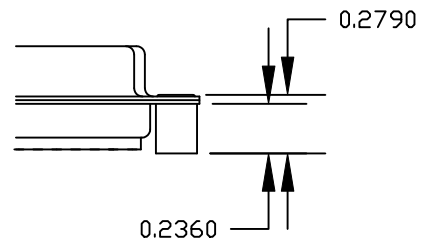

03X..... 0.236" (MATING SIDE) - CN8

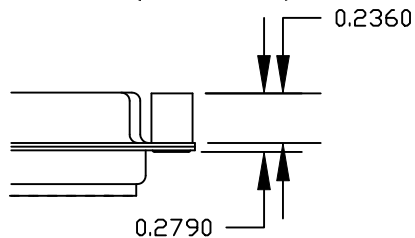

05X ..... 0.237" (BOARD SIDE) - CN10

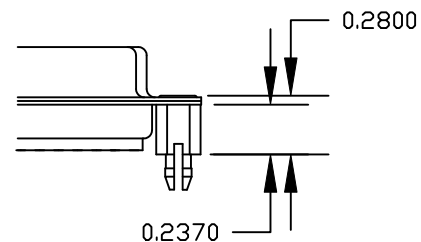

**DO NOT SCALE FROM DRAWING**



THESE DRAWINGS AND SPECIFICATIONS ARE THE PROPERTY OF NorComp AND SHALL NOT BE REPRODUCED, COPIED OR USED AS THE BASIS FOR THE MANUFACTURE OF SALE OF APPARATUS WITHOUT WRITTEN PERMISSION.

DRAWN:  
**M. SIGMON**

DATE:  
**08-23-11**

CHECKED:

DATE:

**NorComp**

SCALE: SHEET **3** OF **4** REV **1**

DWG NO. **680-YYY-113RYY1**

**RoHS COMPLIANT**

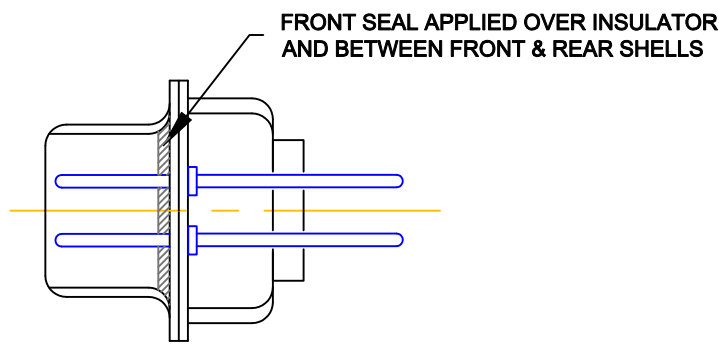
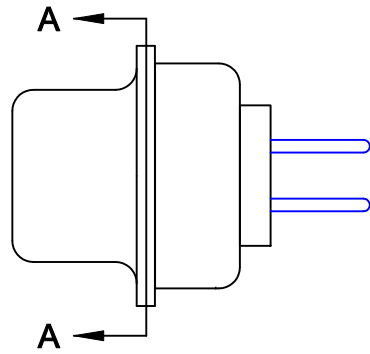

DETAIL A-A

DO NOT SCALE FROM DRAWING

	THESE DRAWINGS AND SPECIFICATIONS ARE THE PROPERTY OF NorComp AND SHALL NOT BE REPRODUCED, COPIED OR USED AS THE BASIS FOR THE MANUFACTURE OF SALE OF APPARATUS WITHOUT WRITTEN PERMISSION.		DRAWN: <b>M. SIGMON</b>	DATE: <b>08-23-11</b>	
			CHECKED:	DATE:	
<h1>NorComp</h1>			SCALE:	SHEET <b>4</b> OF <b>4</b>	REV <b>1</b>
			DWG NO. <b>680-YYY-113RYY1</b>		

RoHS COMPLIANT