

RJ45 10/100/1000 Base-T Jack with Magnetic Module



16.26 x 13.84 x 21.59mm

RoHS
Compliant

ARJ11F

FEATURES:

- Available with or without LED
- Suitable CAT 5 & 6 cable and UTP
- Comply IEEE 802.3ab
- LAN Magnetic with RJ4
- Suitable for RoHS compliant reflow

APPLICATIONS:

- 10/100/1000 base-T LAN
- NIC, LoM and PC

STANDARD SPECIFICATIONS at 25°C

Operating temperature range: 0°C to +70°C Storage temperature range: -40°C to +85°C

Part Number	Turns Ratio ± 5%	EMI Fingers	LEDs	Insertion Loss (dB max)	Return Loss (dB TYP @100Ω±15Ω)				
			L/R	1- 100 MHz	1- 10 MHz	30 MHz	60 80 MHz	80 – 100 MHz	
ARJ11F-MASA-A-B-EM2	1CT:1CT	Yes	G/Y	-1	-20	-16	-12	-10	
ARJ11F-MASB-A-B-EM2	1CT:1CT	Yes	G/Y	-1	-20	-16	-12	-10	
ARJ11F-MBSC-L2	1CT:1	Yes	NONE	-1	-20	-16	-12	-10	
ARJ11F-MASD-AB-A-FM2	1CT:1CT	Yes	G Y/G	-1	-20	-16	-12	-10	
ARJ11F-MASE-A-A-EL2	1CT:1	Yes	G/G	-1	-20	-16	-12	-10	
ARJ11F-MASF-AB-A-FL2	1CT:1	Yes	G Y/G	-1	-20	-16	-12	-10	

Part Number	Crosstalk (dB TYP)			Common Mode Rejection (dB TYP)		Hipot (Vrms)
	1 - 10 MHz	32 - 65 MHz	65 - 100 MHz	1 - 125 MHz	125 -500 MHz	@60Hz
ARJ11F-MASA-A-B-EM2	-40	-35	-30	-30	-20	1500
ARJ11F-MASB-A-B-EM2	-40	-35	-30	-30	-20	1500
ARJ11F-MBSC-L2	-40	-35	-30	-30	-20	1500
ARJ11F-MASD-AB-A-FM2	-40	-35	-30	-30	-20	1500
ARJ11F-MASE-A-A-EL2	-40	-35	-30	-30	-20	1500
ARJ11F-MASF-AB-A-FL2	-40	-35	-30	-30	-20	1500

Contact Abracon for more custom configurations. See options to build a custom configuration.

OPTIONS AND PART IDENTIFICATION

ARJ11F - - - -

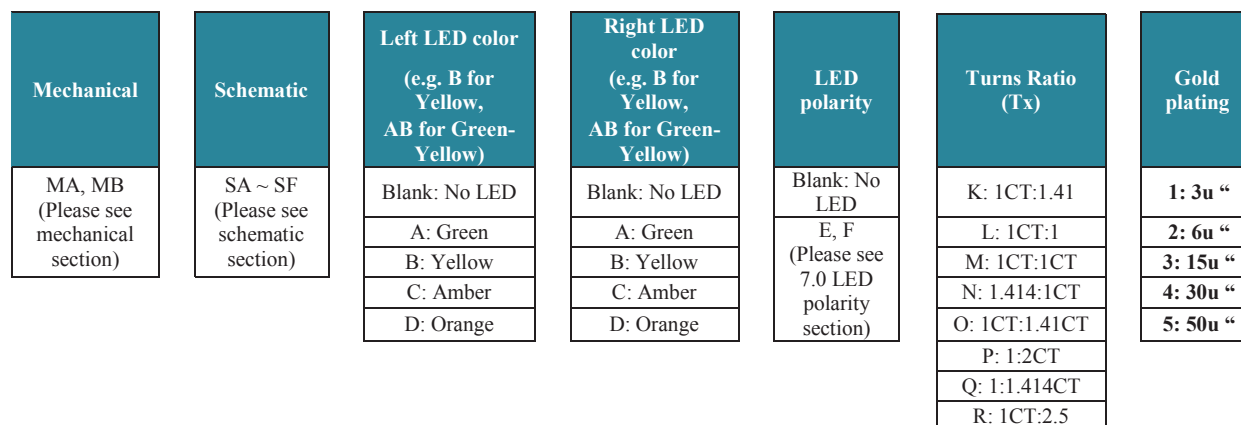

RJ45 10/100/1000 Base-T Jack with Magnetic Module

ARJ11F

RoHS
Compliant



16.26 x 13.84 x 21.59mm

MECHANICAL DIMENSIONS

MA

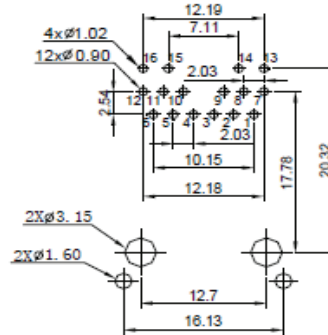
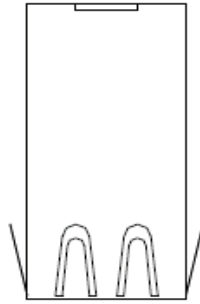

PC Board Layout
Component Side Shown

LED

LED

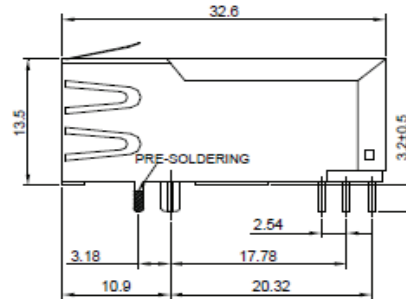
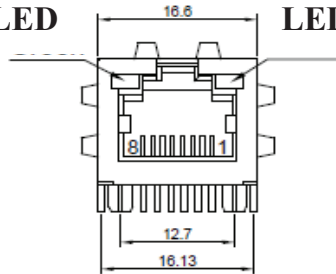

MB

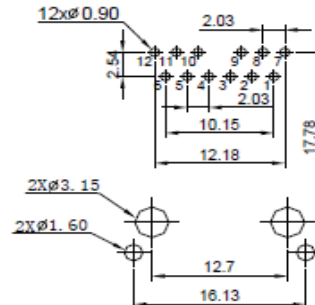
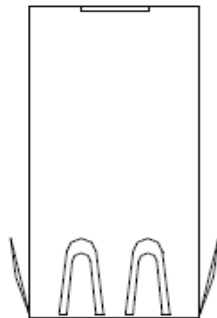

PC Board Layout
Component Side Shown

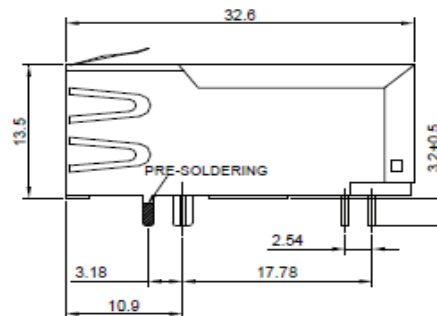
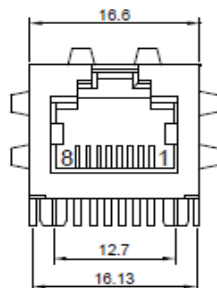

RJ45 10/100/1000 Base-T Jack with Magnetic Module



16.26 x 13.84 x 21.59mm

RoHS
Compliant

ARJ11F

SCHEMATICS

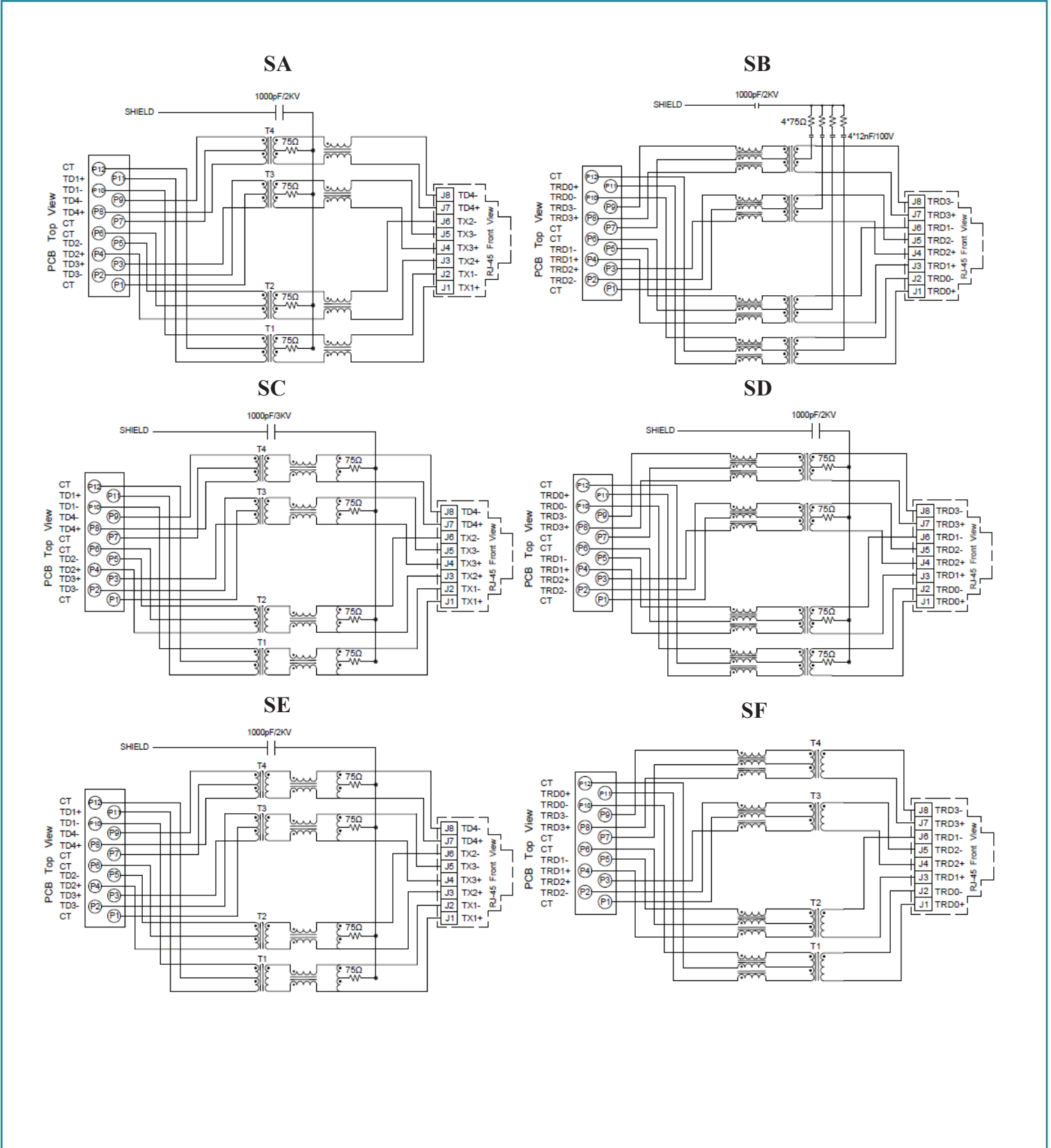

RJ45 10/100/1000 Base-T Jack with Magnetic Module



16.26 x 13.84 x 21.59mm

ARJ11F

RoHS
Compliant

LED POLARITY

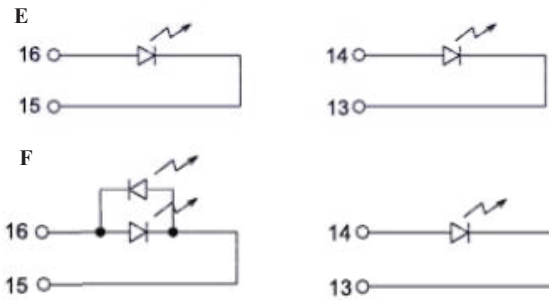

PACKING: 60pcs/tray

Packaging material: PET

Outer carton unit 1320 pcs/ 22 Trays/box

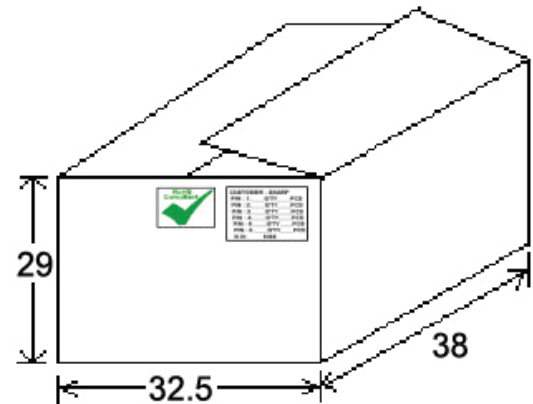
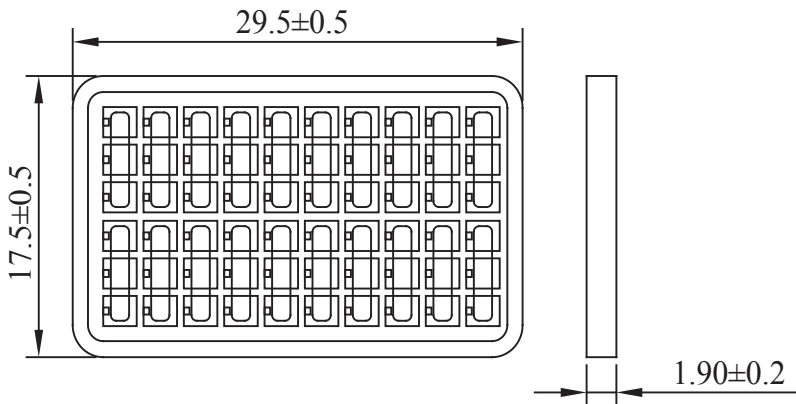

REFLOW PROFILE:

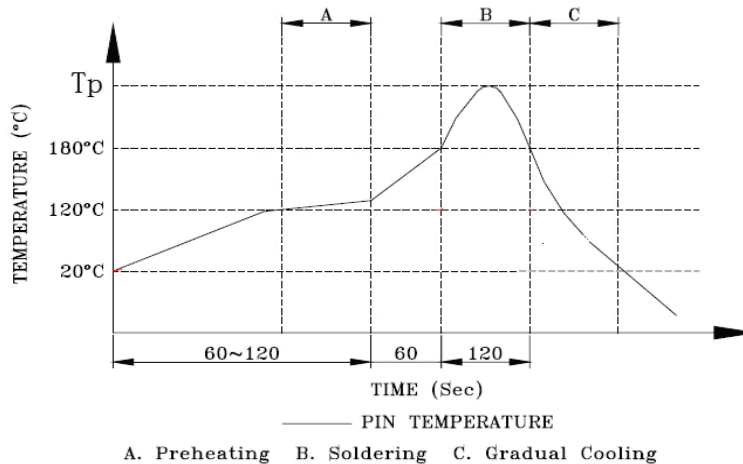

ATTENTION: Abracon Corporation's products are COTS – Commercial-Off-The-Shelf products; suitable for Commercial, Industrial and, where designated, Automotive Applications. Abracon's products are not specifically designed for Military, Aviation, Aerospace, Life-dependant Medical applications or any application requiring high reliability where component failure could result in loss of life and/or property. For applications requiring high reliability and/or presenting an extreme operating environment, written consent and authorization from Abracon Corporation is required. Please contact Abracon Corporation for more information.

ABRACON IS
ISO 9001:2008
CERTIFIED



ABRACON
CORPORATION

Visit www.abracon.com for Terms & Conditions of Sale
30332 Esperanza, Rancho Santa Margarita, California 92688
tel 949-546-8000 | fax 949-546-8001 | www.abracon.com

Revised: 05.09.11