

RJ45 10/100/1000 Base-T Jack with Magnetic Module

ARJ11C

RoHS
Compliant



16.00 x 13.6 x 21.5mm/
16.50 x 13.85 x 26.65 mm

FEATURES:

- Excellent EMI suppression
- Meet IEEE 802.3 standards and FCC mechanical requirements
- Low Cost, RoHS Compliant Reflow-able device

APPLICATIONS:

- LAN-on-Motherboard (LOM)
- SOHO (ADSL modems), Hubs.
- Suitable for CAT 5 & 6 Fast Ethernet Cable or better UTP

STANDARD SPECIFICATIONS at 25°C

Operating Temperature: - 0°C to + 70°C
Storage Temperature: - 40°C to +85°C

Operating life: 750 Cycles min.

Part Number	Turns Ratio		EMI Fingers	LED (L/R)	Insertion Loss (dB max)	Return Loss (dB min @100Ω±15Ω)			
	TX	RX				0.3-100 MHz	1- 30 MHz	40 MHz	50 MHz
ARJ11C-MBSAS-A-BA-□ MU2	1CT:1CT	1CT:1CT	Yes	G/YG	-1.2	-16	-13.5	-11.5	-10
ARJ11C-MBSAT-A-B-□ MU2	1CT:1CT	1CT:1CT	Yes	G/Y	-1.2	-16	-13.5	-11.5	-10
ARJ11C-MBSAS-A-B-□ MU2	1CT:1CT	1CT:1CT	Yes	G/Y	-1.2	-16	-13.5	-11.5	-10
ARJ11C-MBSAU- A-B-□ MU2	1CT:1CT	1CT:1CT	Yes	G/Y	-1.2	-16	-13.5	-11.5	-10
ARJ11C-MCSAT- A-B-□ MU2	1CT:1CT	1CT:1CT	Yes	G/Y	-1.1	-15	-15	-15	-12
ARJ11C-MASAA- B-A-□ LU2	1CT:1	1CT:1CT	Yes	Y/G	-1.2	-14	-14	-14	-10
ARJ11C-MASAB- B-A-□ MU2	1CT:1CT	1CT:1CT	Yes	Y/G	-1.2	-14	-14	-14	-10
ARJ11C-MASAD- A-A-□ MU2	1CT:1CT	1CT:1CT	Yes	G/G	-1.2	-14	-14	-14	-10

Part Number	Crosstalk (dB min)			DCMR (dB min)			Hipot (Vrms)
	30 MHz	60 MHz	100 MHz	30 MHz	60 MHz	100 MHz	
ARJ11C-MBSAS-A-BA-□ MU2	-40	-36	-30	-35	-32	-30	1500
ARJ11C-MBSAT-A-B-□ MU2	-40	-36	-30	-35	-32	-30	1500
ARJ11C-MBSAS-A-B-□ MU2	-40	-36	-30	-35	-32	-30	1500
ARJ11C-MBSAU- A-B-□ MU2	-40	-36	-30	-35	-32	-30	1500
ARJ11C-MCSAT- A-B-□ MU2	-35	-26	-24	-35	-32	-30	1500
ARJ11C-MASAA- B-A-□ LU2	-40	-36	-30	-35	-32	-30	1500
ARJ11C-MASAB- B-A-□ MU2	-40	-36	-30	-35	-32	-30	1500
ARJ11C-MASAD- A-A-□ MU2	-40	-36	-30	-35	-32	-30	1500

DCMR: Differential to Common Mode Rejection

Contact Abracon for more custom configurations. See options to build a custom configuration.

□ : LED Polarity Option

ARJ11C-MA: 1 or 2
ARJ11C-MBSAS: 7
ARJ11C-MB: 3 or 4
ARJ11C-MC: 5 or 6

Contact Abracon for more custom configurations. See options to build a custom configuration.



RJ45 10/100/1000 Base-T Jack with Magnetic Module

ARJ11C

RoHS
Compliant



OPTIONS & PART IDENTIFICATION:

ARJ11C - - - - - - - -

Mechanical	Schematic	Left LED color (e.g. B for Yellow, AB for Green-Yellow)	Right LED color (e.g. B for Yellow, AB for Green-Yellow)	LED polarity	Turns Ratio (Tx)	Turns Ratio (Rx)	Gold plating
MA ~ MC (Please see mechanical section)	SAA ~ SCB (Please see schematic section)	Blank: No LED A: Green B: Yellow C: Amber D: Orange	Blank: No LED A: Green B: Yellow C: Amber D: Orange	Blank: No LED 1 ~ 7 (Please see 7.0 LED polarity section)	K: 1CT:1.41 L: 1CT:1 M: 1CT:1CT N: 1.414:1CT O: 1CT:1.41CT P: 1:2CT Q: 1:1.414CT R: 1CT:2.5	S: 1CT:1.41 T: 1CT:1 U: 1CT:1CT V: 1.414:1CT W: 1CT:1.41CT X: 1:2CT Y: 1:1.414CT Z: 1CT:2.5	1: 3u “ 2: 6u “ 3: 15u “ 4: 30u “ 5: 50u “

OUTLINE DIMENSION:

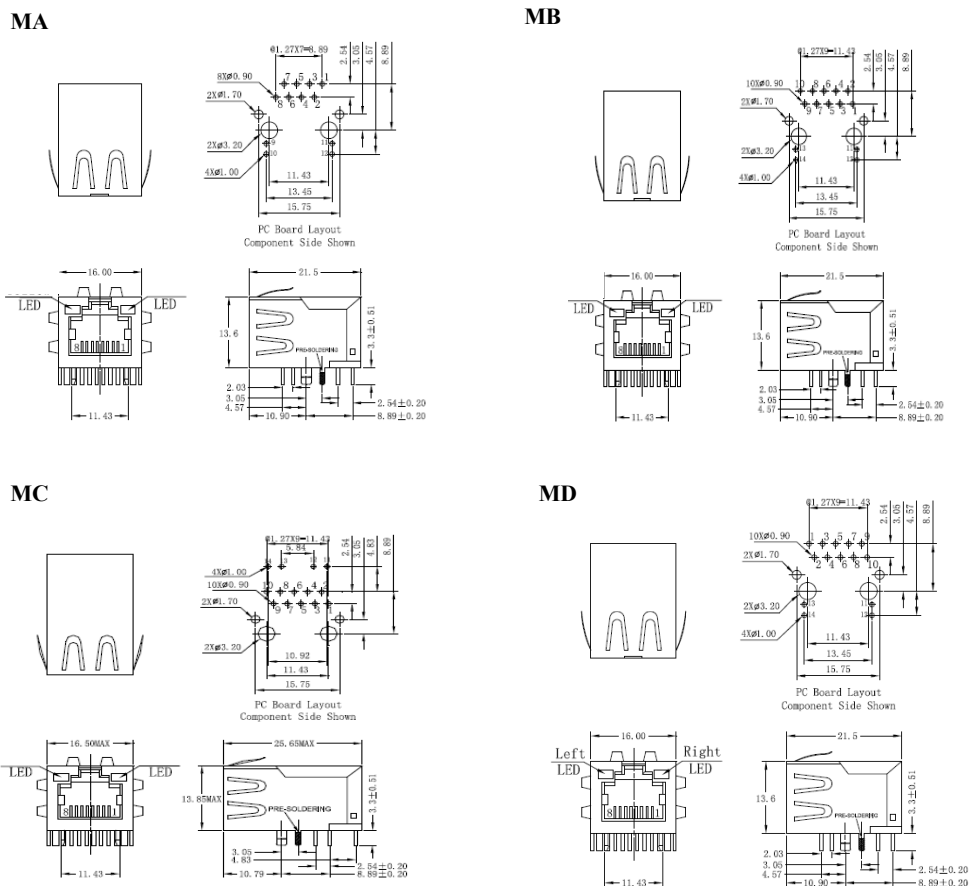

Dimension: mm. All tolerances are ± 0.25

ABRACON IS
ISO 9001:2008
CERTIFIED

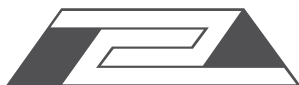

ABRACON
CORPORATION

Visit www.abracon.com for Terms & Conditions of Sale
30332 Esperanza, Rancho Santa Margarita, California 92688
tel 949-546-8000 | fax 949-546-8001 | www.abracon.com

Revised: 11.27.13

RJ45 10/100/1000 Base-T Jack with Magnetic Module

ARJ11C

RoHS
Compliant

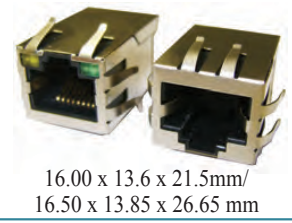

16.00 x 13.6 x 21.5mm/
16.50 x 13.85 x 26.65 mm

SCHEMATICS

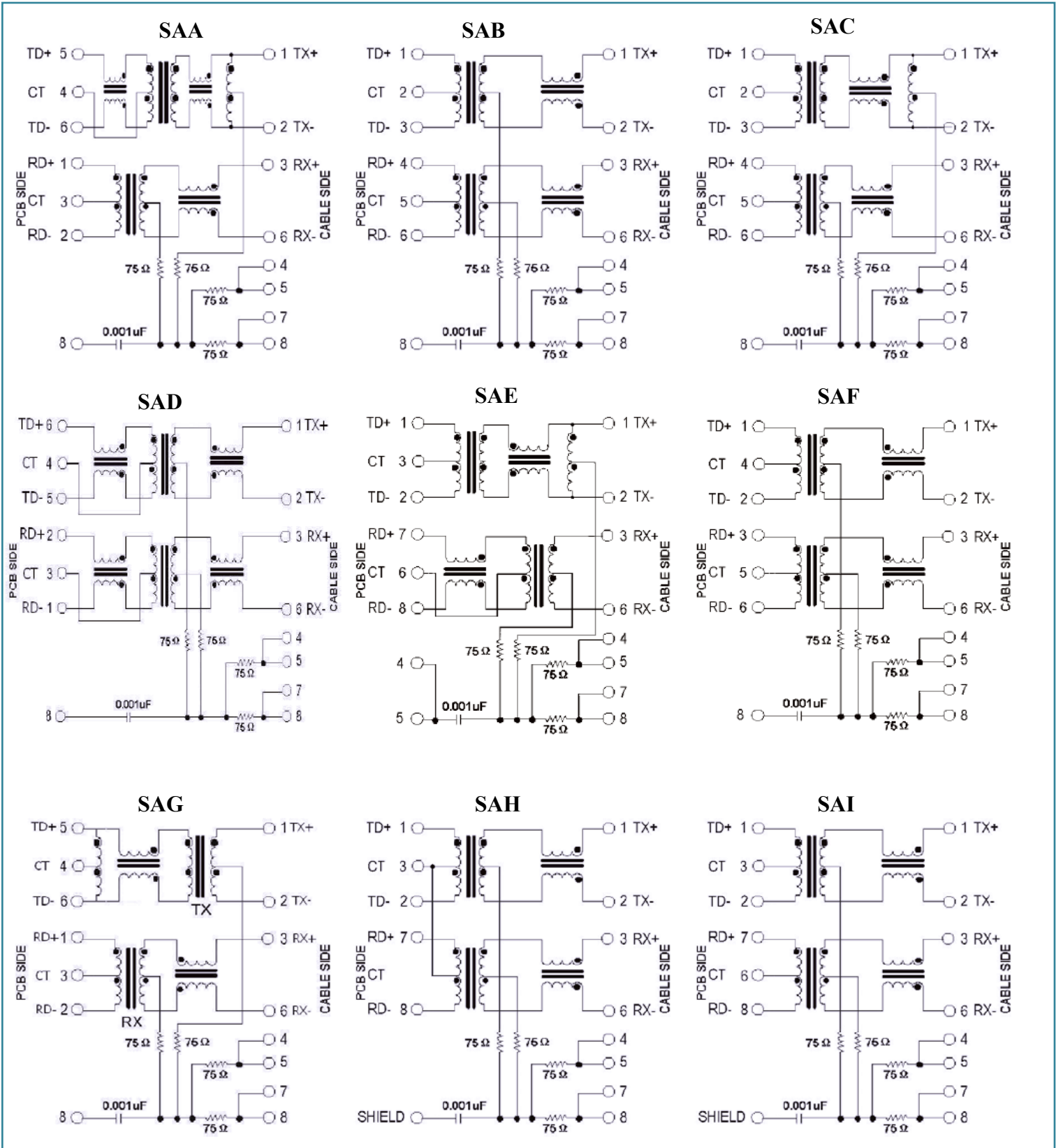

ABRACON IS
ISO 9001:2008
CERTIFIED

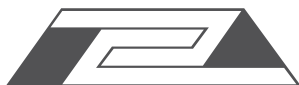

ABRACON
CORPORATION

Visit www.abracon.com for Terms & Conditions of Sale
30332 Esperanza, Rancho Santa Margarita, California 92688
tel 949-546-8000 | fax 949-546-8001 | www.abracon.com

Revised: 11.27.13

RJ45 10/100/1000 Base-T Jack with Magnetic Module

ARJ11C

RoHS
Compliant

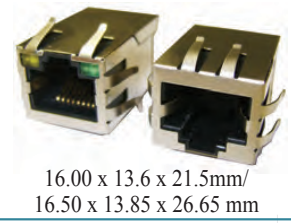

16.00 x 13.6 x 21.5mm/
16.50 x 13.85 x 26.65 mm

SCHEMATICS

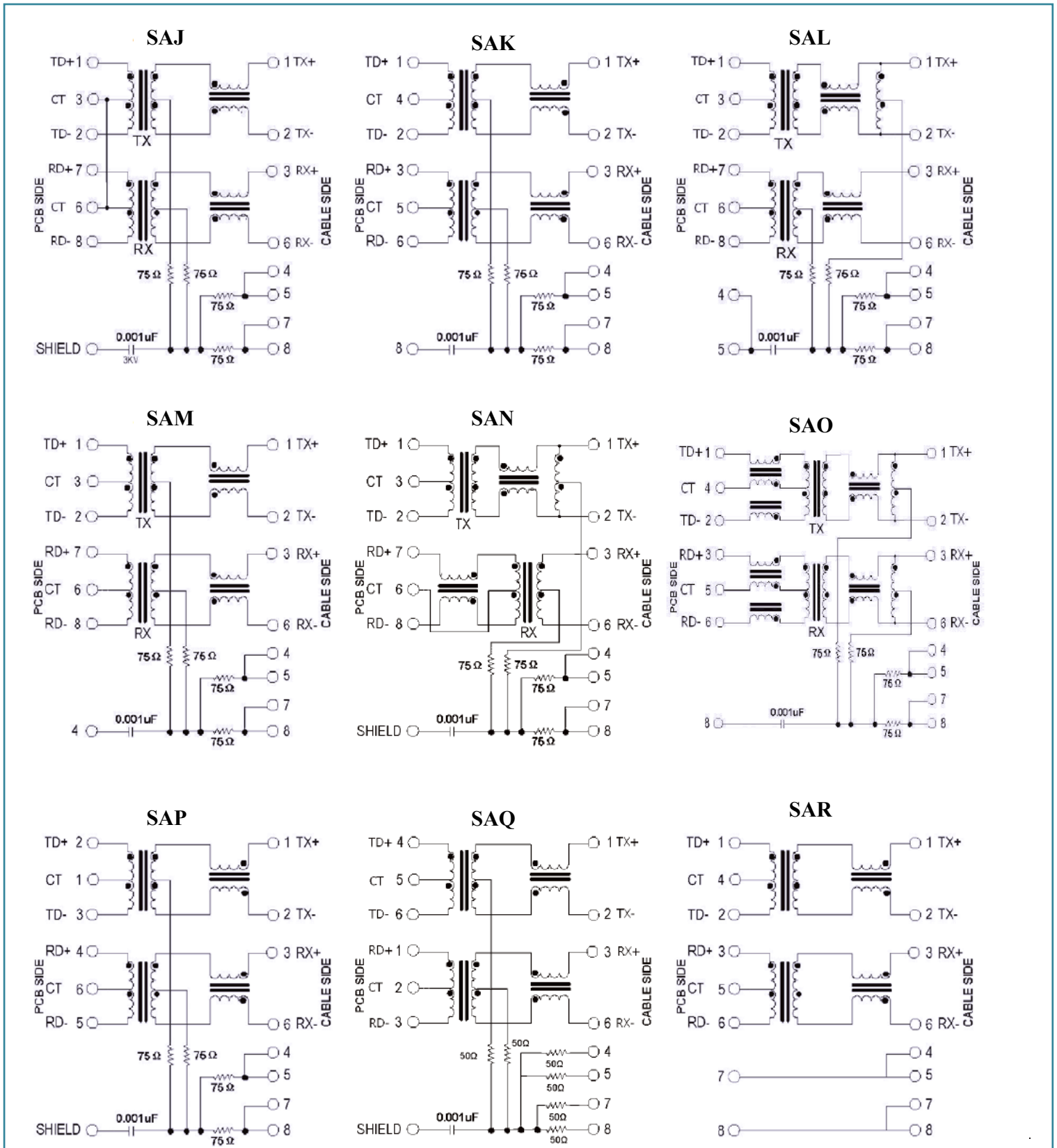

ABRACON IS
ISO 9001:2008
CERTIFIED



ABRACON
CORPORATION

Visit www.abracon.com for Terms & Conditions of Sale
30332 Esperanza, Rancho Santa Margarita, California 92688
tel 949-546-8000 | fax 949-546-8001 | www.abracon.com

Revised: 11.27.13

RJ45 10/100/1000 Base-T Jack with Magnetic Module

ARJ11C

RoHS
Compliant

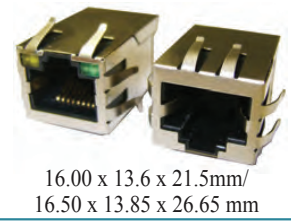

16.00 x 13.6 x 21.5mm/
16.50 x 13.85 x 26.65 mm

SCHEMATICS

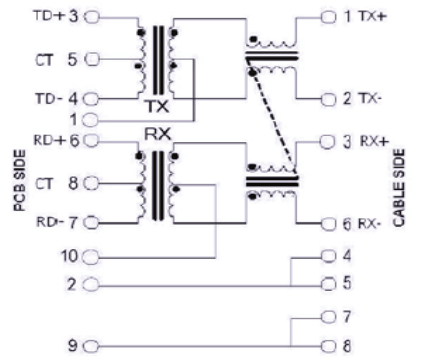
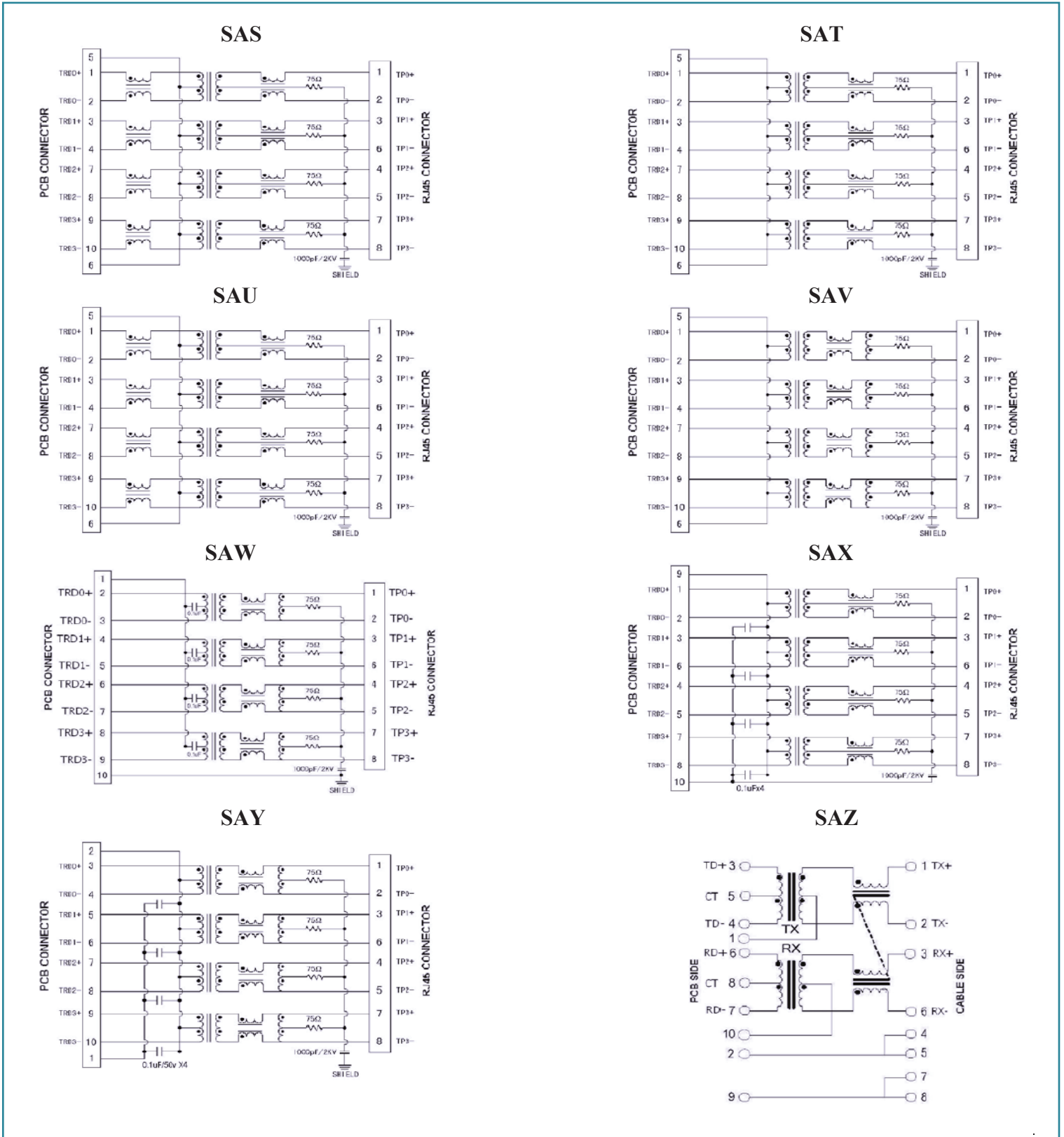

ABRACON IS
ISO 9001:2008
CERTIFIED



Visit www.abracon.com for Terms & Conditions of Sale
30332 Esperanza, Rancho Santa Margarita, California 92688
tel 949-546-8000 | fax 949-546-8001 | www.abracon.com

Revised: 11.27.13

RJ45 10/100/1000 Base-T Jack with Magnetic Module

ARJ11C

RoHS
Compliant

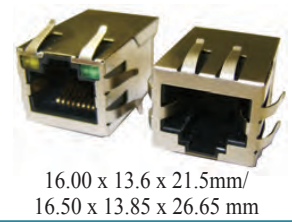

SCHEMATICS

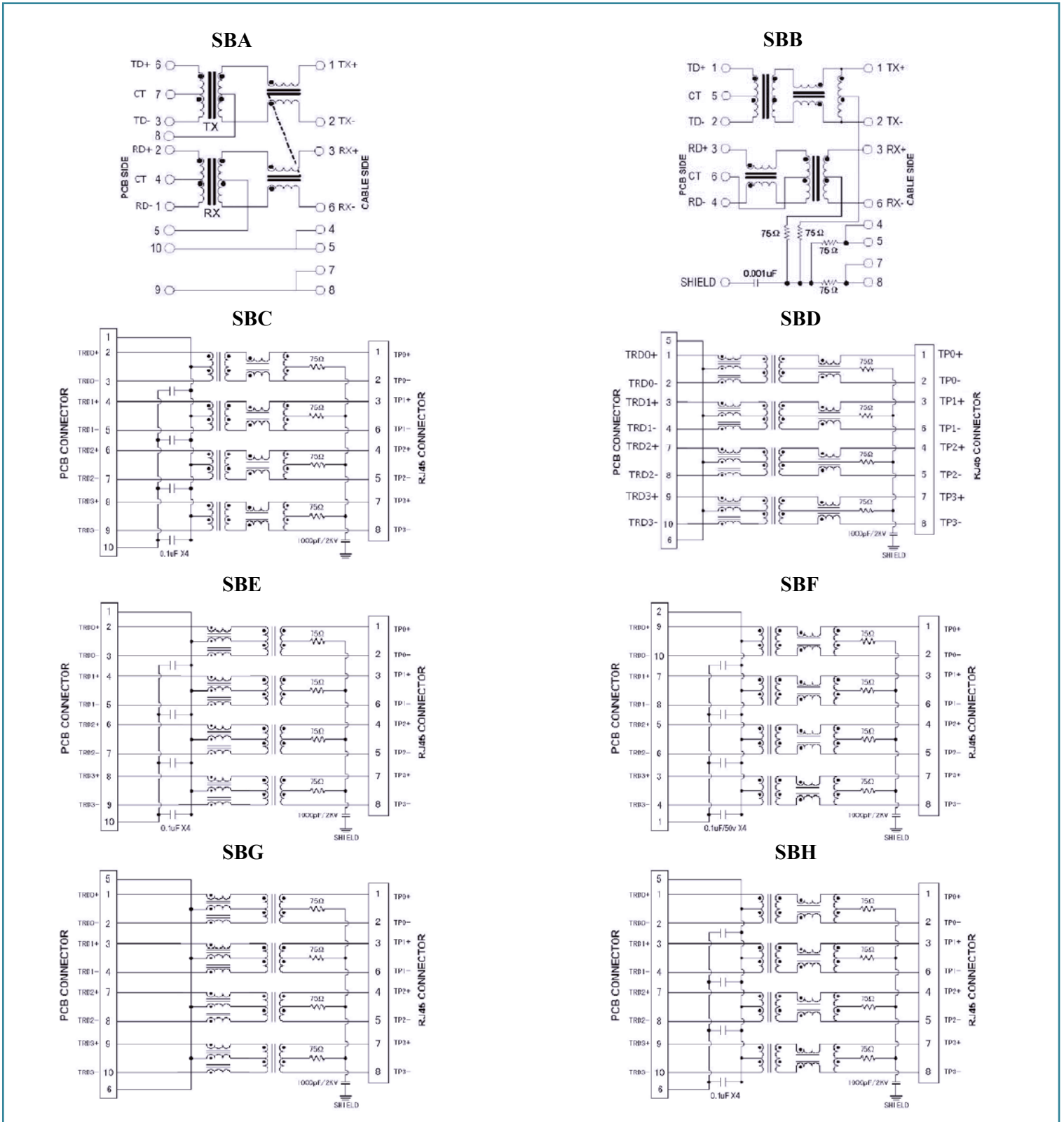

ABRACON IS
ISO 9001:2008
CERTIFIED



ABRACON
CORPORATION

Visit www.abracon.com for Terms & Conditions of Sale
30332 Esperanza, Rancho Santa Margarita, California 92688
tel 949-546-8000 | fax 949-546-8001 | www.abracon.com

Revised: 11.27.13

RJ45 10/100/1000 Base-T Jack with Magnetic Module

ARJ11C

RoHS
Compliant



LED POLARITY

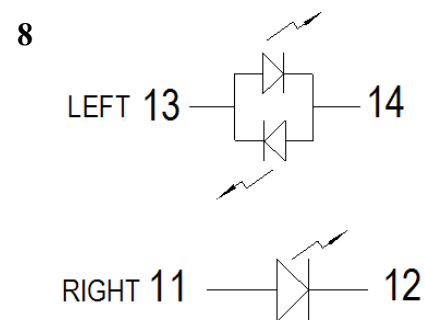
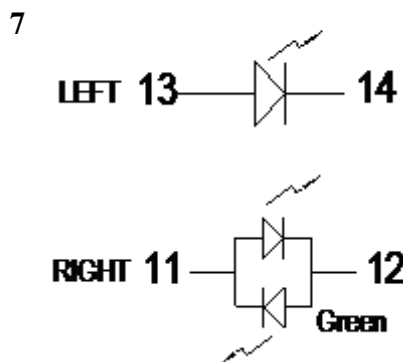
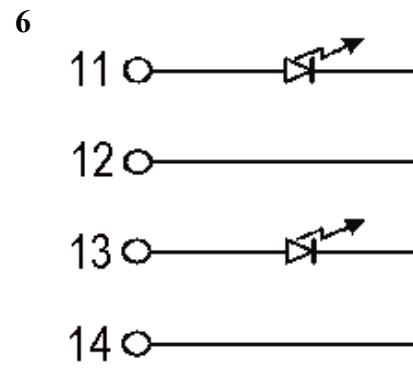
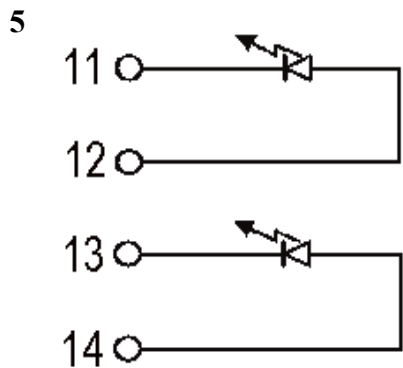
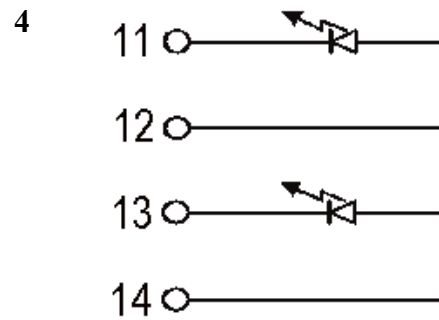
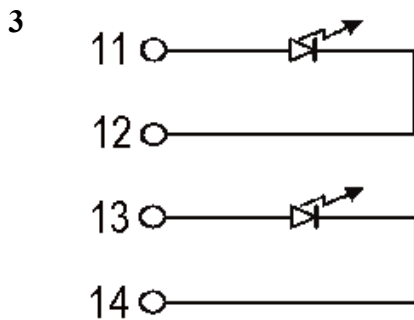
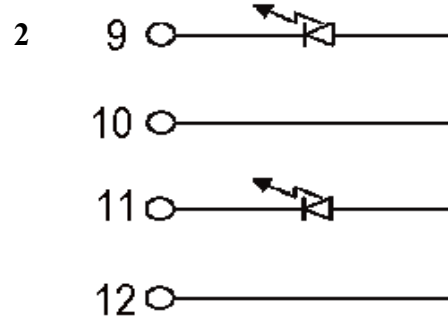
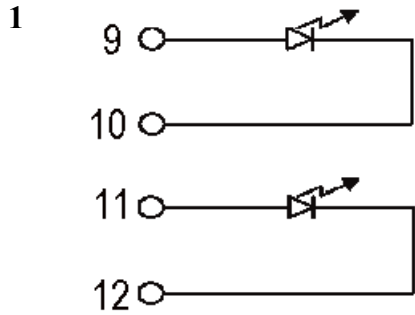

RJ45 10/100/1000 Base-T Jack with Magnetic Module

ARJ11C

RoHS
Compliant



16.00 x 13.6 x 21.5mm/
16.50 x 13.85 x 26.65 mm

REFLOW PROFILE

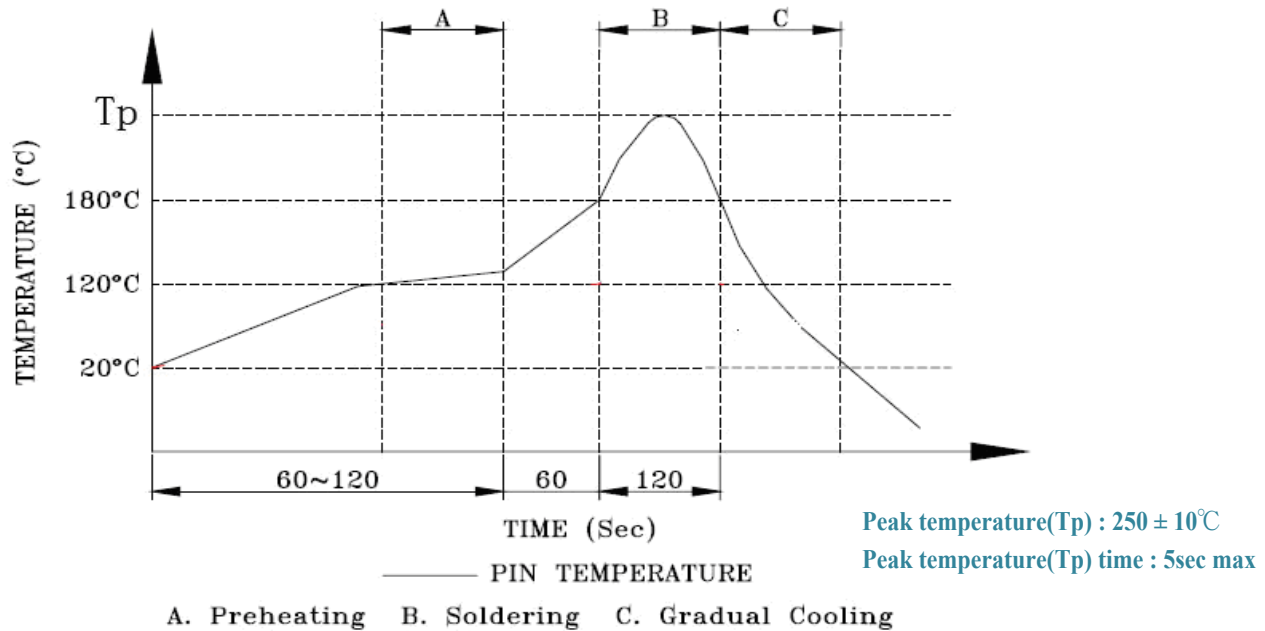

TAPE & REEL:

Packing 60pcs/tray
Packaging material: PET

Outer carton unit 1320 pcs/ 22 Trays/box

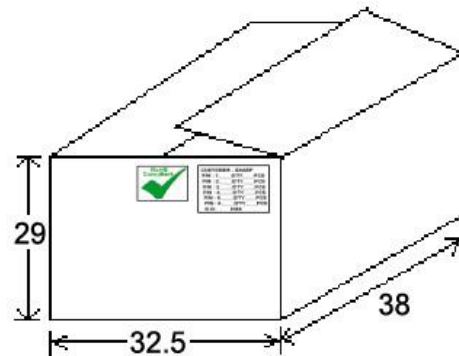
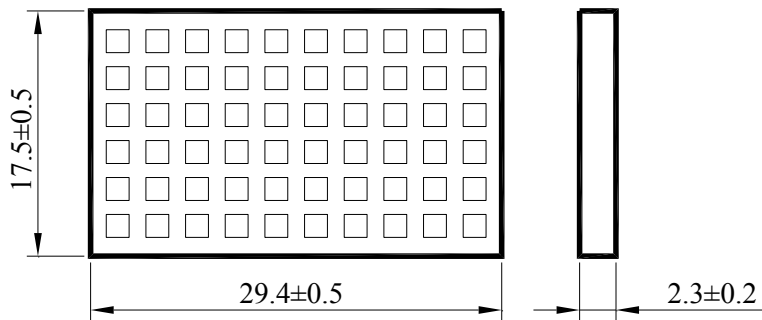

Dimensions: cm

ATTENTION: Abracon Corporation's products are COTS – Commercial-Off-The-Shelf products; suitable for Commercial, Industrial and, where designated, Automotive Applications. Abracon's products are not specifically designed for Military, Aviation, Aerospace, Life-dependant Medical applications or any application requiring high reliability where component failure could result in loss of life and/or property. For applications requiring high reliability and/or presenting an extreme operating environment, written consent and authorization from Abracon Corporation is required. Please contact Abracon Corporation for more information.

ABRACON IS
ISO 9001:2008
CERTIFIED



Visit www.abracon.com for Terms & Conditions of Sale
 30332 Esperanza, Rancho Santa Margarita, California 92688
 tel 949-546-8000 | fax 949-546-8001 | www.abracon.com

Revised: 11.27.13