



Datamate

M80 & M83 SERIES RECTANGULAR CONNECTORS

DECEMBER 2015

SECTION	TITLE	PAGE
1	Description of Connectors and Intended Applications	2
2	Marking of Connector and/or Package	2
3	Ratings	3
Appendix 1	Contact Orientations	7
Appendix 2	Coax Contact Details 	10
Appendix 3	Gauges (Low Frequency)	12
Appendix 4	Test for Latch Integrity 	13
Appendix 5	Instructions for the use of connectors fitted with Jackscrews	14
Appendix 6	Instructions for the use of  Jackscrews	15

PREPARED BY:.....Matthew Perren.....

APPROVED BY:.....Mark Pleased.....

Sheet: 1 of 15
 Issue: 27
 Date: 02.12.2015
 C/Note: 12947



1. DESCRIPTION OF CONNECTOR AND INTENDED APPLICATION

A range of 2mm pitch male and female rectangular, fully shrouded unsealed connectors with replaceable contacts for interconnecting board to board, cable to board and cable to cable. The range covers 2 to 50 ways, in various application methods. Female connectors are available for crimp, vertical through-board and surface mount termination. Male connectors are available for crimp, vertical or horizontal (90°) through-board and vertical surface-mount termination. Overmoulding of cable assemblies is also available for crimp versions.

The connectors are provided with a range of contact terminations (as shown in Appendix 1) that are gold or gold/tin plated. The contact zone of a gold plated contact is hard acid gold of 98% purity.

The connector is intended for use as a low voltage connector in high packing density electronic equipment. The connector is polarised to prevent mis-matching and can be produced with a latching feature (L-Tek) or in a jackscrew (J-Tek) format, with or without board mounting.

L-Tek and J-Tek connectors are available with low-frequency (LF) contacts, while customised Mixed Technology (Mix-Tek) connectors are also available with jackscrews, with a choice of power or coax contacts.

NOTE: Some connector styles are available manufactured and tested to BS9525 F0033. All other connectors in the range are designed to the same specification.

2. MARKING OF THE CONNECTOR AND/OR PACKAGE [ORDER CODE]

The marking (order code) shall appear on the package and shall be as follows:

2.1. ORDER CODE:

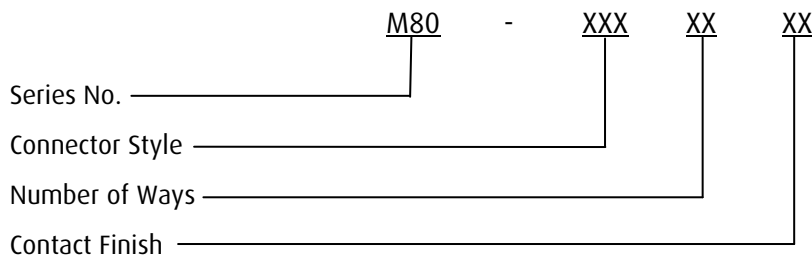

For details of styles, as well as Mix-Tek and M83 markings and styles see the latest catalogue, or individual drawings.

2.1.1. Number of ways:

SINGLE ROW (standard)	No. of ways	2	3	4	5	6	7	17	22
	Order Code	02	03	04	05	06	07	17	22

DOUBLE ROW (standard)	No. of ways	2+2	3+3	4+4	5+5	6+6	7+7	8+8	9+9	10+10	13+13	17+17	22+22
	Order Code	04	06	08	10	12	14	16	18	20	26	34	44

DOUBLE ROW (jackscrew)	No. of ways	3+3	5+5	7+7	10+10	13+13	17+17	21+21	25+25
	Order Code	06	10	14	20	26	34	42	50



2.1. FINISH CODES (CONTINUED)

2.1.2. Contact Finish:

Finish Code	01	05	22	42
Male PC Tail	--	Gold all over	Gold on Contact area Tin /Lead on tail	Gold on Contact area 100% Tin on tail
Male Crimp	--	Gold all over	--	--
Female PC Tail	Gold on Contact area Tin /Lead on tail	Gold all over	--	Gold on Contact area 100% Tin on tail
Female Crimp	--	Gold clip, Gold shell	--	Gold clip, Gold shell

3. RATINGS

All materials are listed on individual drawings.

3.1. LOW-FREQUENCY SIGNAL CONNECTORS

3.1.1. Electrical characteristics

- Current – per individual contact at an ambient temperature of 25°C3.3A max
(When only one contact per connector is electrically loaded)
- Current – per individual contact at an ambient temperature of 85°C2.6A max
(When only one contact per connector is electrically loaded)
- Current – per contact through all contacts at an ambient temperature of 25°C.....3.0A max
- Current – per contact through all contacts at an ambient temperature of 85°C2.2A max
- Working Voltage (at 1013mbar, sea level)800V DC or AC Peak
- Voltage Proof (at 1013mbar, sea level)1200V DC or AC Peak
- Contact resistance (initial)20mΩ max
- Contact resistance (after conditioning)25mΩ max
- Insulation resistance (initial).....1,000 MΩ min
- Insulation resistance (hot after conditioning).....100 MΩ min
- Creepage path contact-to-contact0.35mm min
- Air gap contact-to-contact0.35mm min

3.1.2. Environmental characteristics

- Environmental classification.....-55/+125/56 Days at 95% RH
- Low air pressure severity when only one contact is electrically loaded.....300 mbar (9,144M/30,000ft)*
- Vibration severity10Hz to 2000Hz over 0.75mm at 98m/s² (10G), duration 6 hours
- Vibration severity10Hz to 81.73Hz @ 1.5mm peak to peak, 57.55Hz to 2000Hz
@ 20g. duration 2 hours
- Bump severity390m/s² (40G), 4000 ±10 bumps
- Shock severity981m/s² (100G) for 6ms



3. RATINGS (continued)

3.1.2. Environmental characteristics (continued)

Acceleration severity.....490m/s² (50G)

Salt Spray:

L-Tek:

BS2011 Part 2.1Kb Severity 2 (5% Solution – 6.5/7.2pH @ 40°C / 93% Humidity for 66 Hours.)

J-Tek & Mix-Tek:

EIA364 Test Procedure 26 condition A (5% Solution – 6.5/7.2pH @ 35°C / 95% Humidity for 96 Hours.)

**The connector will function correctly using a simultaneous combination of high temperature and low air pressure down to 300mbar (Altitude of 9,144M/30,000ft) up to 360V DC.*

3.1.3. Mechanical characteristics

Durability500 operations

Clip retention in body..... 18N min

Minimum retention force may be 10N from a sample of 10 sockets, providing the average of the samples is 22N.

High temperature, long term (current as in 3.1.).....1000 hours at 85°C

High temperature, short term (no electrical load).....250 hours at 125°C

Contact retention in moulding 10N min*

** Male Crimp Jackscrew contact replacement – 2 operations at 10N*

Contact holding force 0.2N min

M80 insertion force (per contact, using mating pin, no latch fitted)..... 2.0N max

M80 withdrawal force (per contact, using mating pin, no latch fitted)..... 0.2N min

M83 insertion force (per contact, using mating pin, no latch fitted)..... 1.0N max

M83 withdrawal force (per contact, using mating pin, no latch fitted)..... .0.2N min

3.1.4. Wire Termination Range

Wire type (recommended)..... BS 3G 210 Type A

Crimp Type	Small Bore	Small Bore	Small Bore	Large Bore
No. & Nominal dia. (mm) of wires	7 / 0.12	7 / 0.15	7 / 0.2	19 / 0.15
A.W.G.	28	26	24	22
Minimum pull-off force	12.5N	25N	44N	50N
M22520/2-01 Crimp tool setting	6	6	6	6
Max. insulation diameter	Ø1.10mm			

Extra small bore crimp contact details

Crimp type	Extra small bore		
No. & nominal dia. (mm) of wires	7/0.12	1/0.25	7/0.08
AWG	28	30	32
Min. pull off force	12.5N	7N	4N
M22520/2-01 crimp tool setting	5	4	4
Max. insulation diameter	Ø0.75mm		

3.2. COAX CONTACTS

3.2.1. Electrical characteristics

Impedance50Ω
 Frequency Range 6GHz (Also dependent on cable type or board layout)

3. RATINGS (continued)

3.2. COAX CONTACTS (continued)

V.S.W.R. (Voltage Standing Wave Ratio) 1.05 + (0.04 x Frequency) GHz max
 Operating Voltage (at 1013mbar, sea level) 180V AC at 500mA
 Maximum Voltage (at 1013mbar, sea level) 1,000V AC rms
 Contact Resistance 6 mΩ max
 Insulation Resistance (at 250V rms) 10⁶ MΩ

3.2.2. Wire Termination Range

Cable Type	Max. Insulation Diameter	Compatible contacts
RG 178	Ø2.0mm	M80-305, M80-308, M80-315, M80-318
PTFE cellular	Ø2.4mm	M80-306, M80-316
RG 174	Ø2.7mm	M80-307, M80-309, M80-317, M80-319
RG 179	Ø2.7mm	M80-307, M80-309, M80-317, M80-319
RG 316	Ø2.7mm	M80-307, M80-309, M80-317, M80-319

3.2.3. Mechanical characteristics

Durability500 operations
 Insertion force:8.0N max
 Withdrawal force:0.5N min
 Contact wipe 1.30mm min
 Contact replacement in moulding5 times max

3.3. POWER CONTACTS

3.3.1. Electrical characteristics

Current rating (M80-3XX contact only)20A max
 Current rating (M80-PXX contact only)40A max
 Working Voltage (at 1013mbar, sea level)800V DC or AC Peak
 Voltage Proof (at 1013mbar, sea level)1200V DC or AC Peak
 Contact Resistance6mΩ max

3.3.2. Wire Termination Range

A.W.G.	Current Rating of cable	Compatible contacts
10	40A max	M80-PF5, M80-PM5
12	20A max	M80-325, M80-335, M80-32A
14	15A max	M80-326, M80-336, M80-32B
16	10A max	M80-327, M80-337, M80-32C
18	8A max	M80-328, M80-338
20	5A max	M80-329, M80-339

3.3.3. Mechanical characteristics

Durability	500 operations
High temperature, long term (no electrical load).....	1000 hours at 150°C
Insertion force M80-3XX contacts	8.0N max
Insertion force M80-PXX contacts	15.0N max
Withdrawal force	0.5N min
Contact wipe	1.30mm min
Contact replacement in moulding	5 times max

3.4. SOLDERING DATA

Solderability (for PC Tail & SMT product).....	245°C for 5 seconds
Soldering heat resistance (for SMT products only).....	260°C for 10 seconds

APPENDIX 1 – CONTACT ORIENTATIONS

These diagrams show pin numbers with reference to the polarisation feature. They represent male connectors, shown looking onto the contact face.

A1.1. Datamate L-Tek SINGLE ROW

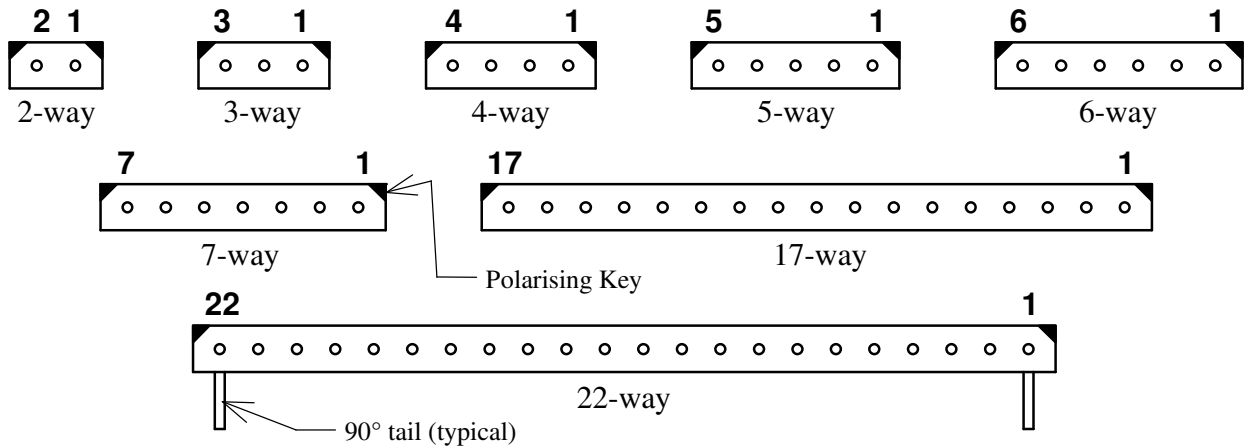

A1.2. Datamate L-Tek DOUBLE ROW

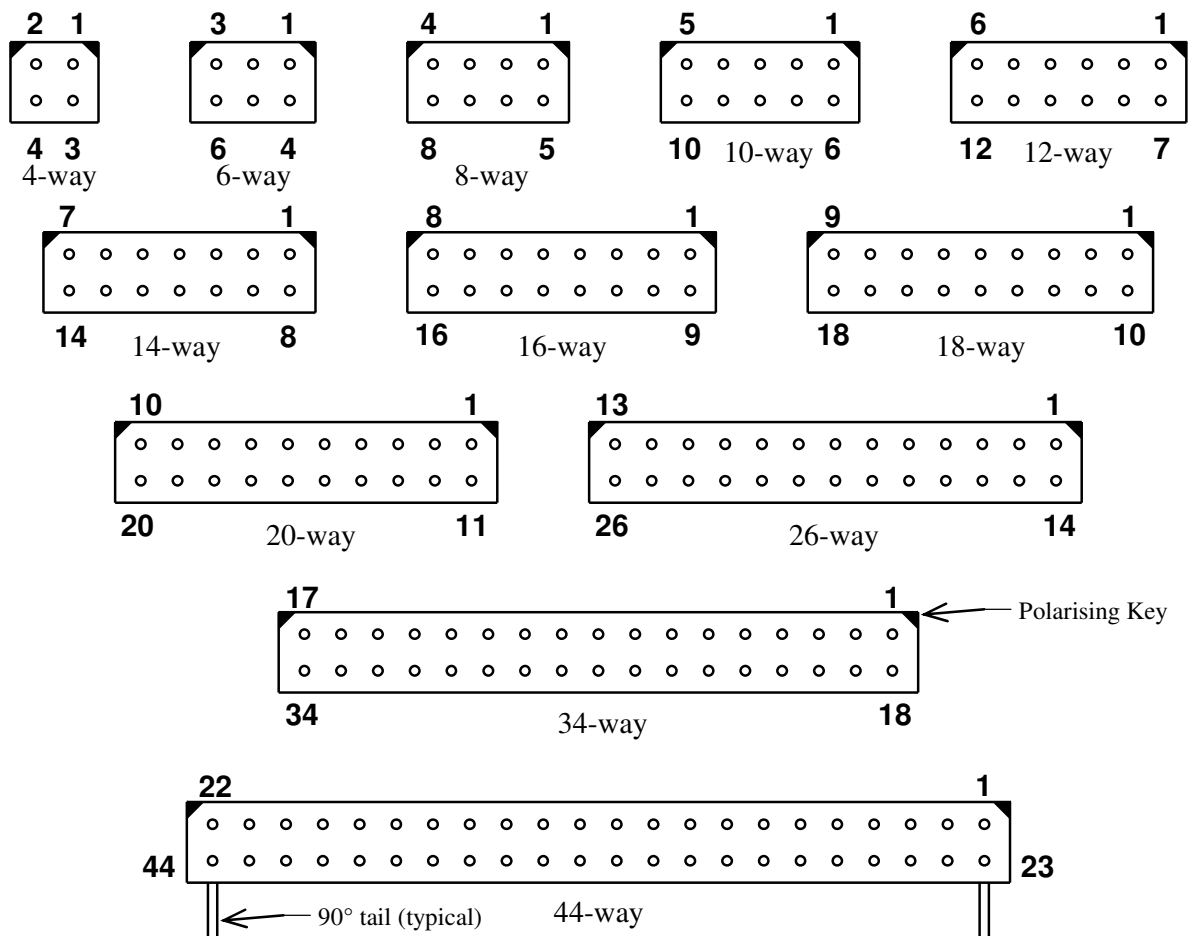

APPENDIX 1 – CONTACT ORIENTATIONS (continued)

These diagrams show pin numbers with reference to the polarisation feature. They represent male connectors, shown looking onto the contact face.

A1.3. M80 Datamate J-Tek DOUBLE ROW

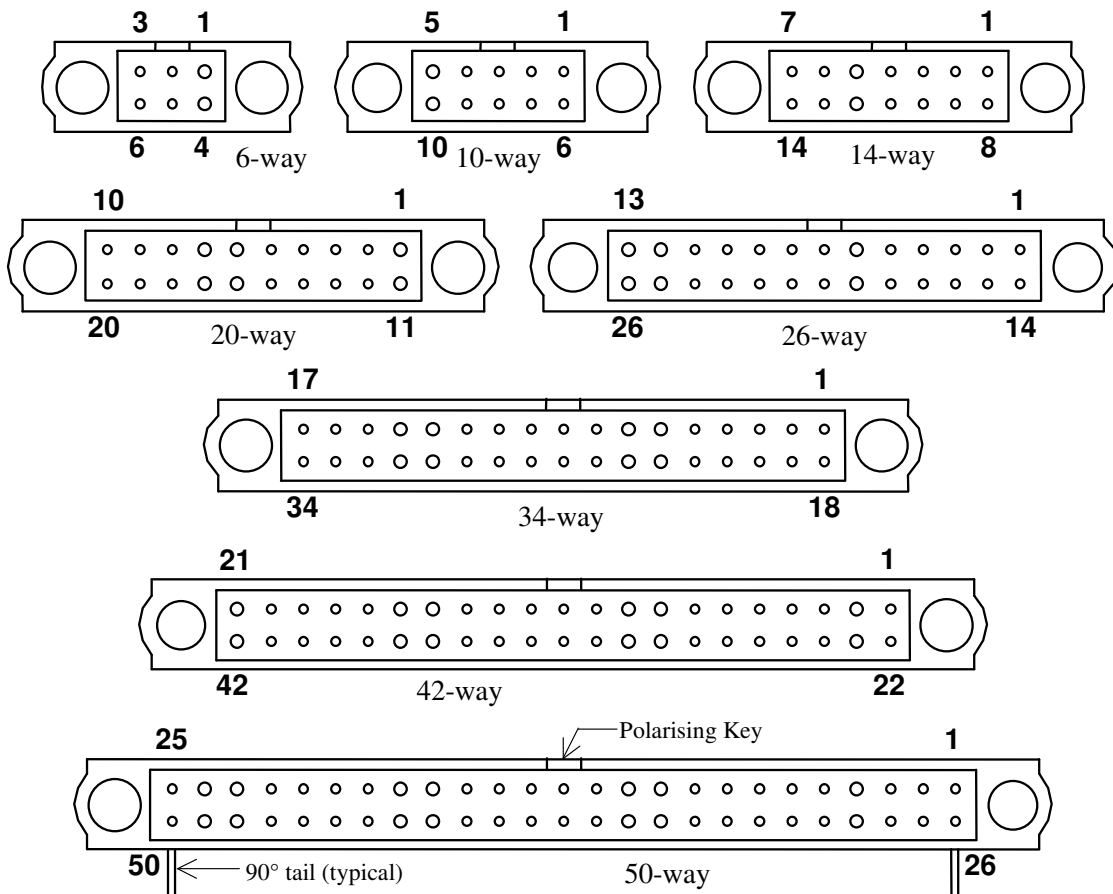

A1.4. M80 Datamate Mix-Tek DOUBLE ROW

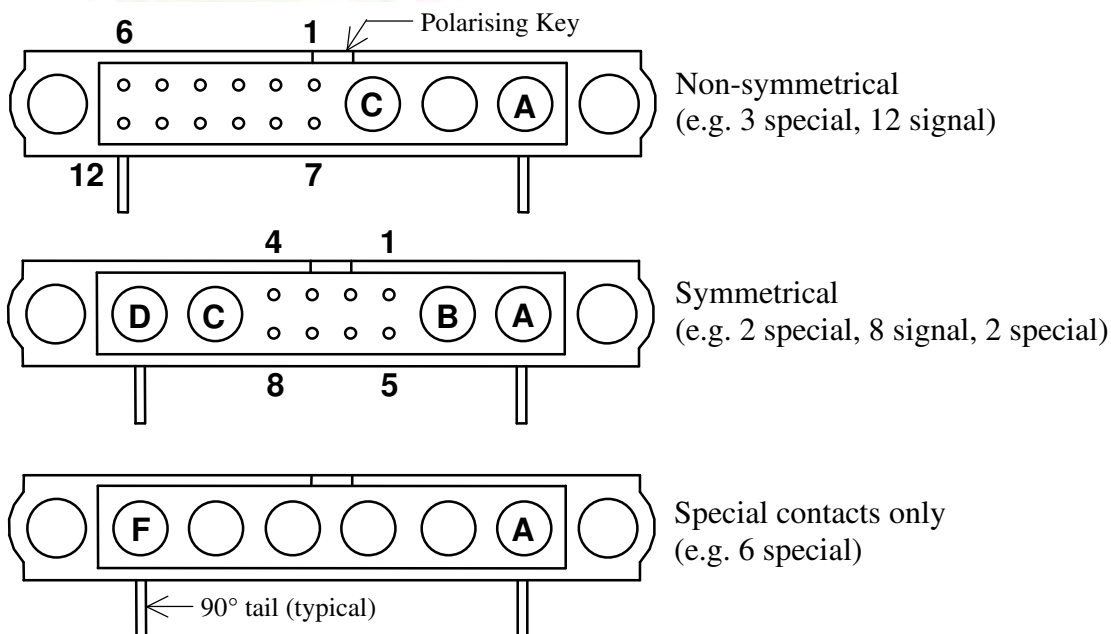

APPENDIX 1 – CONTACT ORIENTATIONS (continued)

These diagrams show pin numbers with reference to the polarisation feature. They represent male connectors, shown looking onto the contact face.

A1.5 M83 Datamate J-Tek 3 ROW

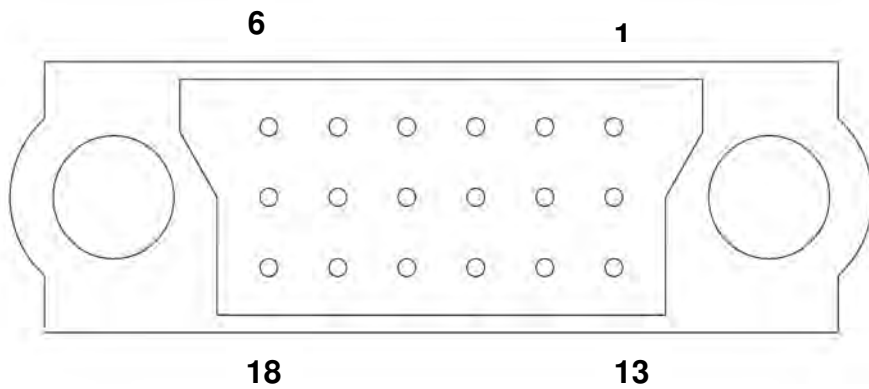

All signal contacts only

A1.6. M83 Datamate Mix-Tek 3 ROW

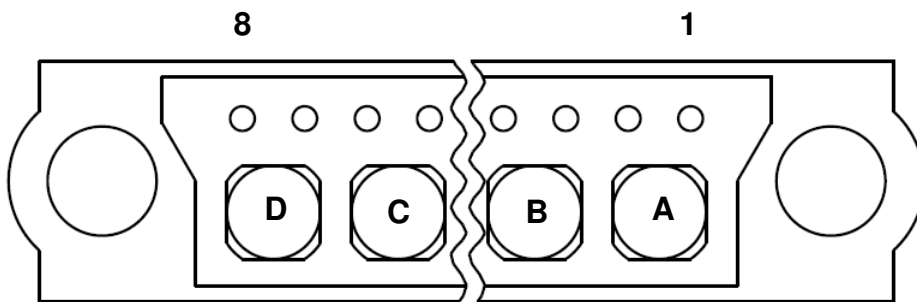

Signal and special contacts

APPENDIX 2 – COAX CONTACT DETAILS

A2.1. COAX INTERFACE DIMENSIONS

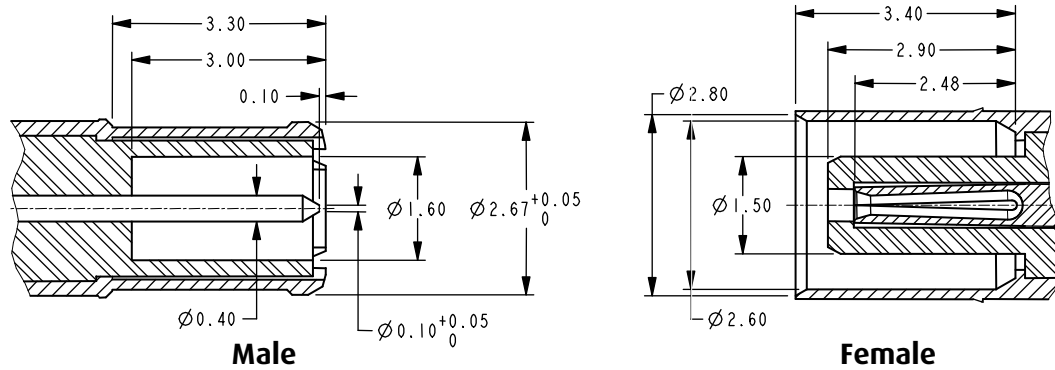

A2.2. COAX ASSEMBLY INSTRUCTIONS – M80-305/306/307, M80-315/316/317

1) Strip cable to dimensions shown against relevant part (see appropriate engineering drawings).

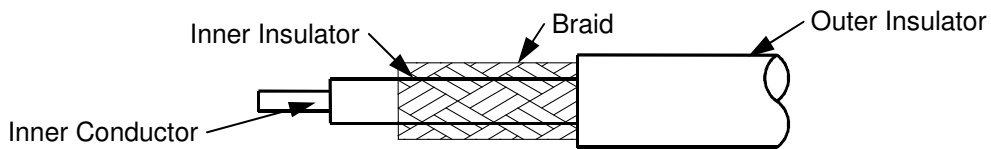

2) Identify pieces of coax connector to be assembled.

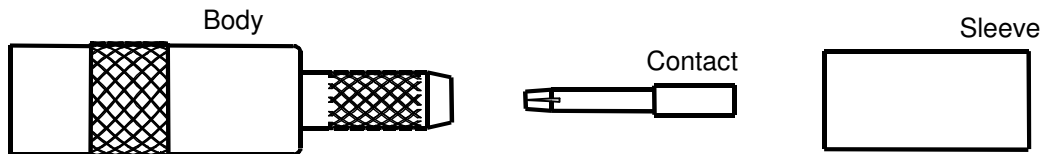

3) Slide sleeve onto cable past stripped area.

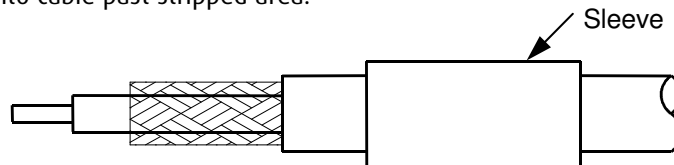

4) Crimp contact to end of cable inner conductor.

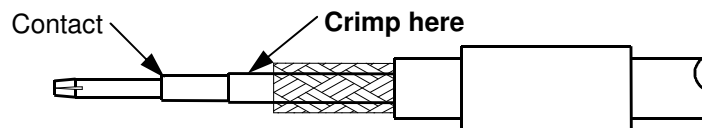

5) Insert cable and contact into coax body from back end - make sure that the braid goes outside and over the end section.

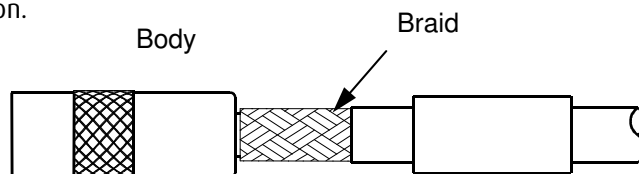

6) Slide sleeve back over the end of the coax body and the braid. Crimp into place on the cable insulation, using a hexagonal crimping tool.

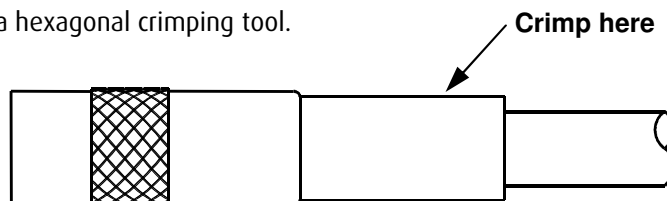

APPENDIX 2 – COAX CONTACT DETAILS (continued).

A2.3. COAX ASSEMBLY INSTRUCTIONS – M80-308/309, M80-318/319.

1) Strip cable to dimensions shown against relevant part (see appropriate engineering drawings).

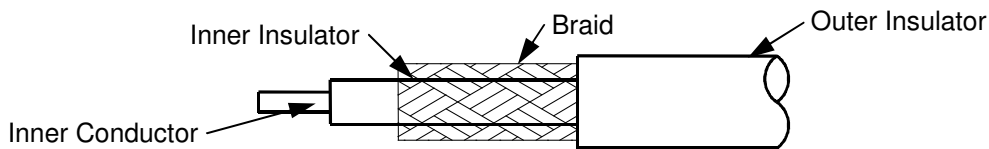

2) Identify pieces of coax connector to be assembled.

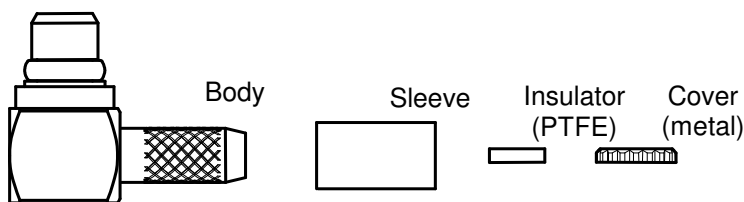

3) Slide sleeve onto cable past stripped area.

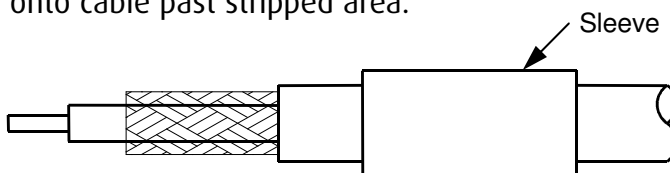

4) Push the cable and sleeve into the body, as far as it will go. The cable inner conductor will be visible through the hole in the top of the coax body, and should go into the slot in the inner contact of the body. Make sure that the braid goes outside and over the end section.

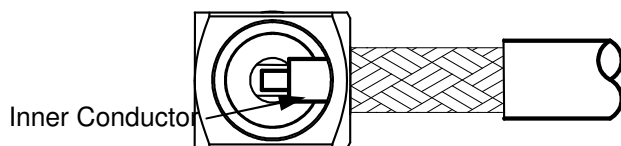

5) Solder the cable inner conductor to the body inner contact. When cool, place the insulator inside the top, and press the cover into place. Slide the sleeve up to meet the coax body, and hexagonal crimp in place.

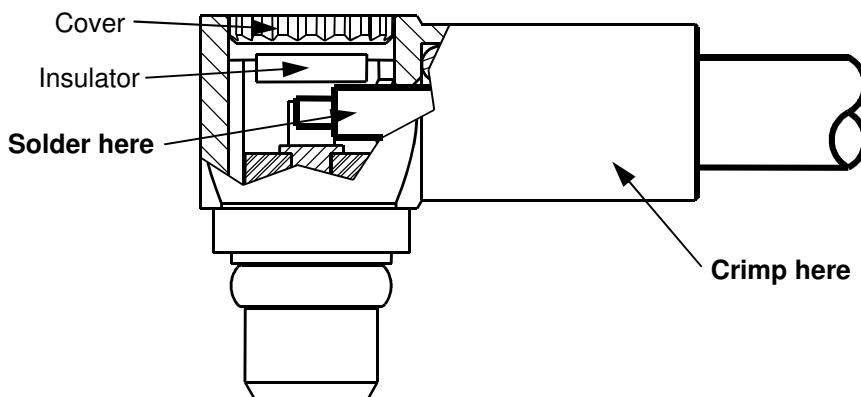

APPENDIX 3 – GAUGES (LOW FREQUENCY)

NOTES:

1. Material = Steel to BS1407 or equivalent.
2. Gauging surfaces to be hardened/ground to 650 H.V.5 minimum.
3. These gauges to be used for testing fully assembled components only.
4. Ultimate wear limit of 0.005mm is allowable on gauging diameters.
5. Loading force (Bending moment) to give 0.002Nm (Test prod only).
6. All dimensions are in millimetres.
7. For explanation of dimensions, etc. see BS8888.
8. Unless otherwise stated, all dimensions are maxima.

A3.1. TEST PROD

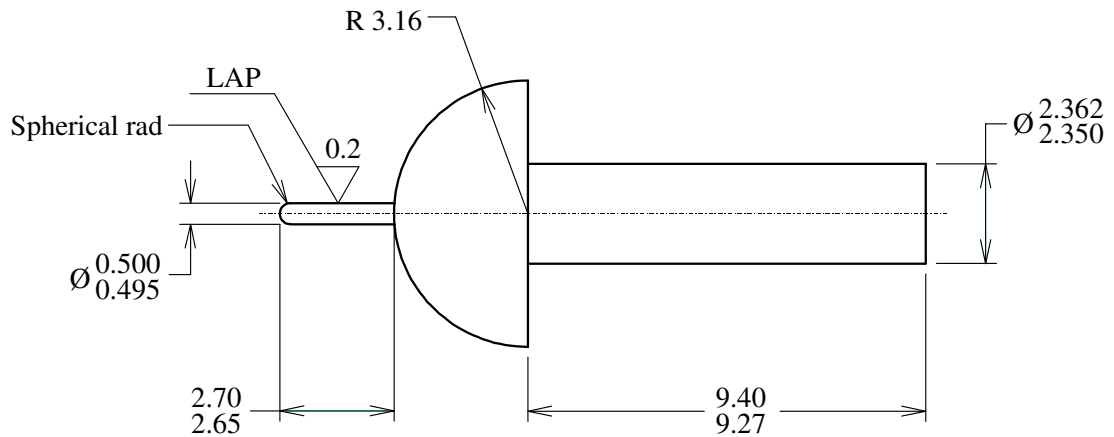

A3.2. SIZING GAUGE

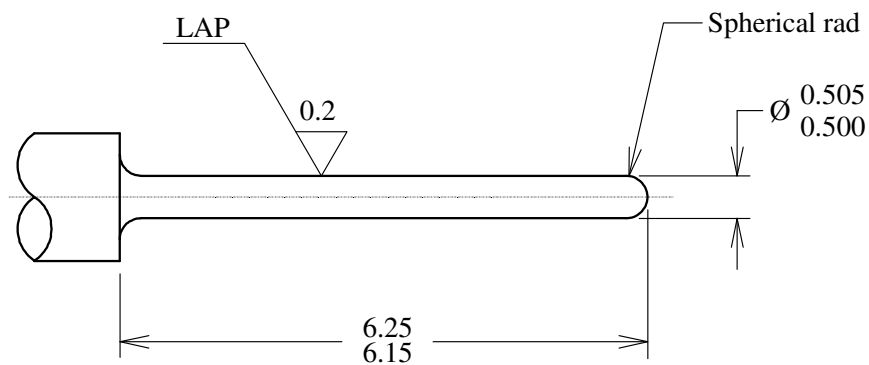

A3.3. HOLDING GAUGE (Mass = 20 +0/-1 gm)

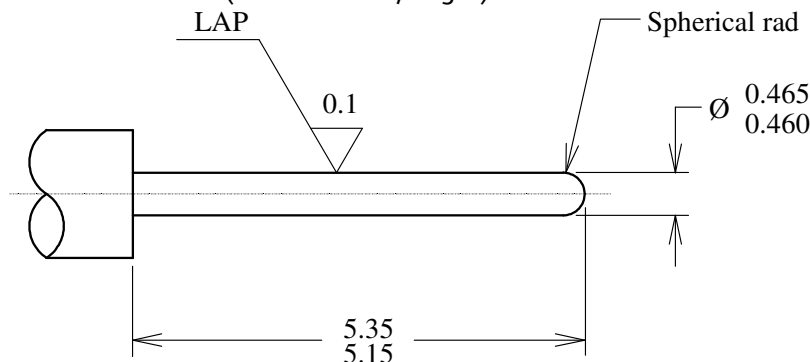

APPENDIX 4 – TEST FOR LATCH INTEGRITY Datamate L-Tek

A4.1. LATCH INTEGRITY GAUGE

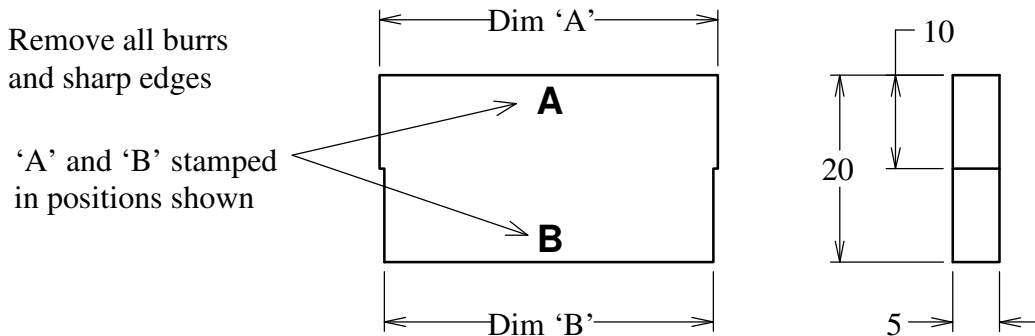

No. of contacts per row	2	3	4	5	6	7	8	9	10	13	17	22
Dim 'A' +0.00 / -0.02	6.00	8.00	10.00	12.00	14.00	16.00	18.00	20.00	22.00	28.00	36.00	46.00
Dim 'B' +0.02 / -0.00	5.00	7.00	9.00	11.00	13.00	15.00	17.00	19.00	21.00	27.00	35.00	45.00

A4.2. LATCH INTEGRITY TEST

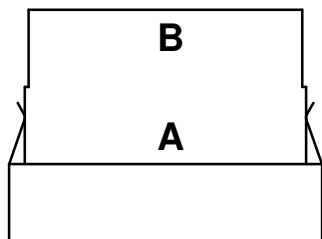

Figure 1

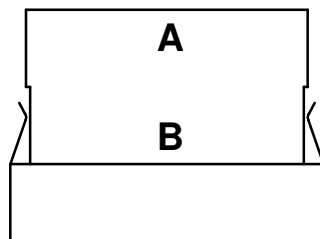

Figure 2

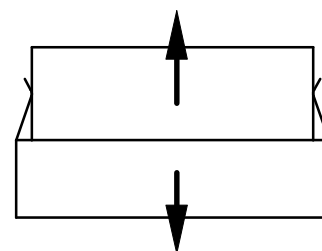

Figure 3

When Gauge A is placed between the two faces of the latch clips (as shown in Figure 1), the connector shall be held against its own weight.

When Gauge B is placed between the two faces of the latch clips (as shown in Figure 2), the connector shall not be held against its own weight.

When an unloaded female connector moulding is mated with a latched male connector, and a force of 20N is applied for 10 seconds in the directions shown in Figure 3, there shall be no failure of any part of the latch mechanism.

**APPENDIX 5 – INSTRUCTIONS FOR THE USE OF CONNECTORS FITTED WITH JACKSCREWS
(Datamate Mix-Tek , Datamate J-Tek)**

Connectors are fitted with jackscrews where it is considered necessary to provide mechanical assistance in ensuring a satisfactory engagement and separation of the connector. This may apply in cases where engagement and separation forces are so high as to prevent satisfactory hand engagement, or where access to connector is restricted. Jackscrews also provide a locking feature, preventing the connector from disengaging under adverse conditions.

In order to obtain maximum effectiveness from the jackscrew system, the following rules for their use should be observed.

1. The connector with boardmount jackscrews should be fixed to the mounting board with fixings and tightened to a torque of $21 \pm 2 \text{cmN}$.
2. On engaging the two halves of the connector after ensuring correct polarity, lightly push home the floating half until the jackscrews touch. Then, maintaining the pressure, turn one of the floating jackscrews clockwise, until it engages with the fixed screw. Repeat with the other screw.

Then screw in each jackscrew, ensuring even loading by applying a maximum of one turn to each screw in sequence until the connector is bottomed. This will be evident by a sudden increase in the torque required on the screw. This torque should not exceed 23cmN .

NB: Care to be taken when aligning male and female threads to avoid cross-threading and possible failure of parts.

3. On disengaging the two halves of the connector turn each of the floating jackscrews anti-clockwise. Again ensure even loading by turning each screw in sequence for a maximum of one turn until the jackscrew disengage. The connector can then be easily pulled apart.
4. Board mounting fixings must be fitted before Wave soldering.
5. Board mounting fixings can be fitted before or after reflow soldering, as preferred by customer. If fitted before soldering, check that the fixings remain tight after soldering.

APPENDIX 6 – INSTRUCTIONS FOR THE USE OF  JACKSCREWS

1. Before engaging, the slot on the jackscrew should be at right angles to the length of the connector.
2. Push the connectors together. Once the connectors are mated, use a screwdriver to push down onto each 101Lok Jackscrew until the spring is compressed. Turn the Jackscrew 101 degrees, and release. The Jackscrew should remain partially compressed.
3. To disengage, use a screwdriver to push down on each 101Lok Jackscrew until the spring is compressed. Turn the Jackscrew anti-clockwise 101 degrees, and release. The Jackscrew will spring back to its uncompressed position.